

<: * , \$B

87! 87

J% \$\$

Ki \Ub ; i] XY HYW\bc` c[m 7c" ž@hX"



87! 87

%"

%" %

%" &

%" '

%" (

%")

%

F78

F7A

F78

F7A

6

F78

F78

F78

F78

&

87! 87

&

GUIDE

kkk" [XYhYWVta

% &

f!%&

!

f!%&

87! 87

u s u B88Δ p#X+AMR+
A

ê

i 8Δ
#

kkk" [XYhYWWVta

GUIDE

&" (87! 87

% 87! 87 #

#

&"

&" (" &

-)IF<

%\$\$\$

%\$\$\$

%\$\$

%

' \$\$\$



''

''%

HF680N 09F — □□□ — 4

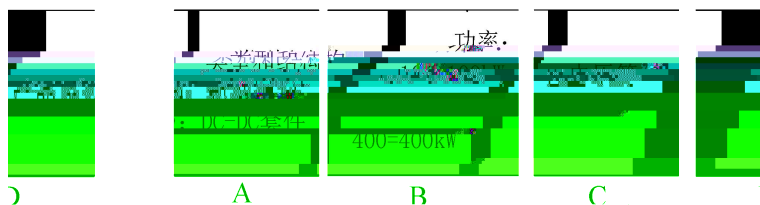

''%%

5	*, \$B
6	\$-A 87! 87 \$-: 87! 87
7	'
8	(\$\$J

'!%

''%&

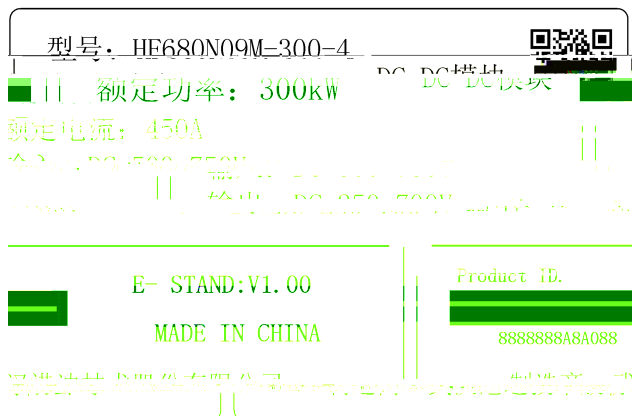

''%' 87! 87

87! 87		J ₈₇ J	f15k	f1_kk	J ₈₇ fUk
< *, \$B\$-: ! %\$\$! (< *, \$B\$-A! %\$\$! (&) \$! +\$\$	%\$	%\$\$) \$\$! +) \$
< *, \$B\$-: ! &\$\$! (< *, \$B\$-A! &\$\$! (&) \$! +\$\$	' \$\$	&\$\$) \$\$! +) \$
< *, \$B\$-: ! &*)! (< *, \$B\$-A! &*)! (&) \$! +\$\$	(\$\$	&*)) \$\$! +) \$
< *, \$B\$-: ! ' \$\$! (< *, \$B\$-A! ' \$\$! (&) \$! +\$\$	() \$	' \$\$) \$\$! +) \$
< *, \$B\$-: ! (\$\$! (< *, \$B\$-A! (\$\$! (&) \$! +\$\$	*\$\$	(\$\$) \$\$! +) \$



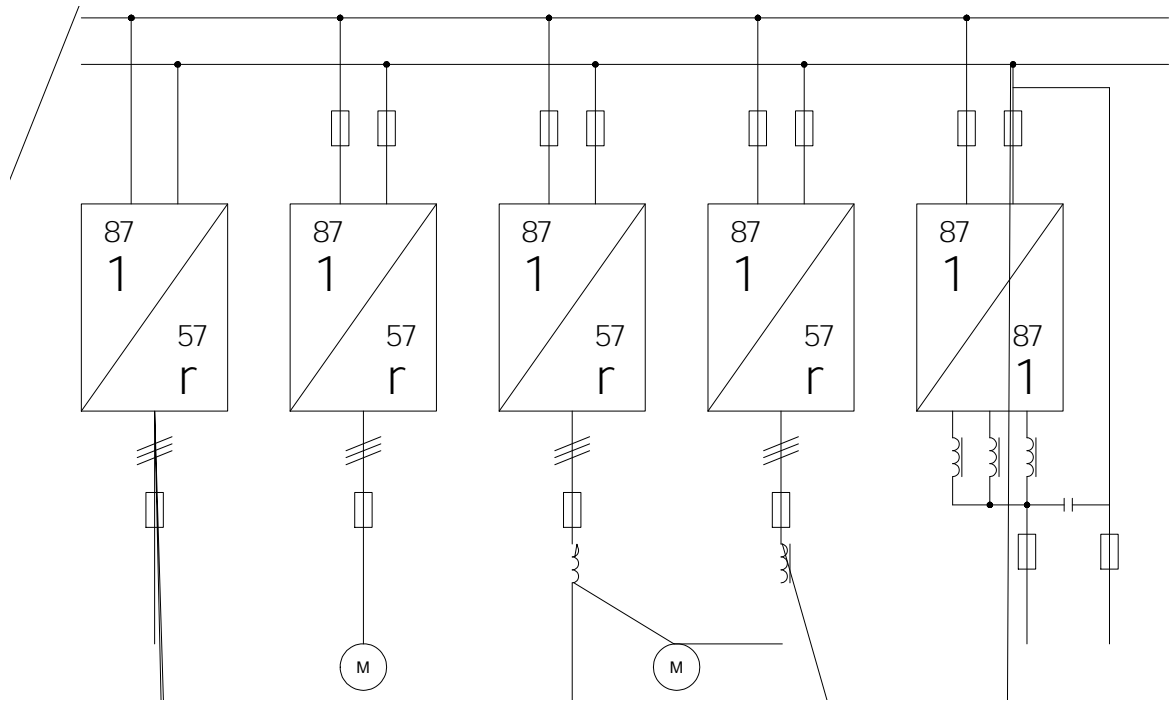

' "(

(" &" %

87! 87



' " (" (

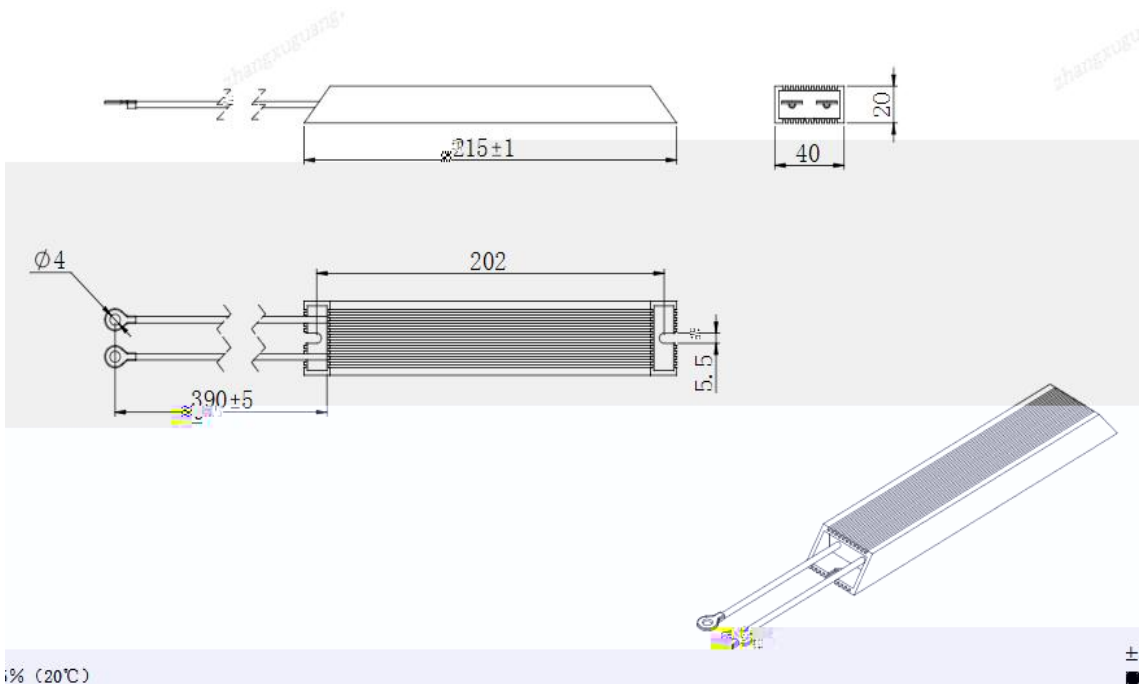

87! 87

< *, \$B\$-: ! %\$\$! (

; 8< *, \$B<7! %\$\$! , \$\$

("

("% 87! 87

%\$Vá

)Vá

*

!%\$ Z(\$
(\$

% %
)\$

!&\$ Z*\$
% #

!&\$ Z*\$

!%\$

+\$ %\$* _DU
\$" + %" \$)

+\$ %\$* _DU
\$" + %" \$)

\$ %\$ _DU
\$" * %" \$)

%\$<n Z)+<n
)<n Z *+<n

\$" \$+) aa
\$"

(" & &

%

GUIDE

kkk" [XYhYWVta

("&" (

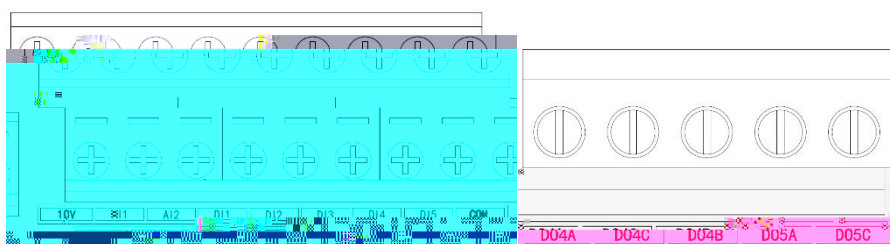
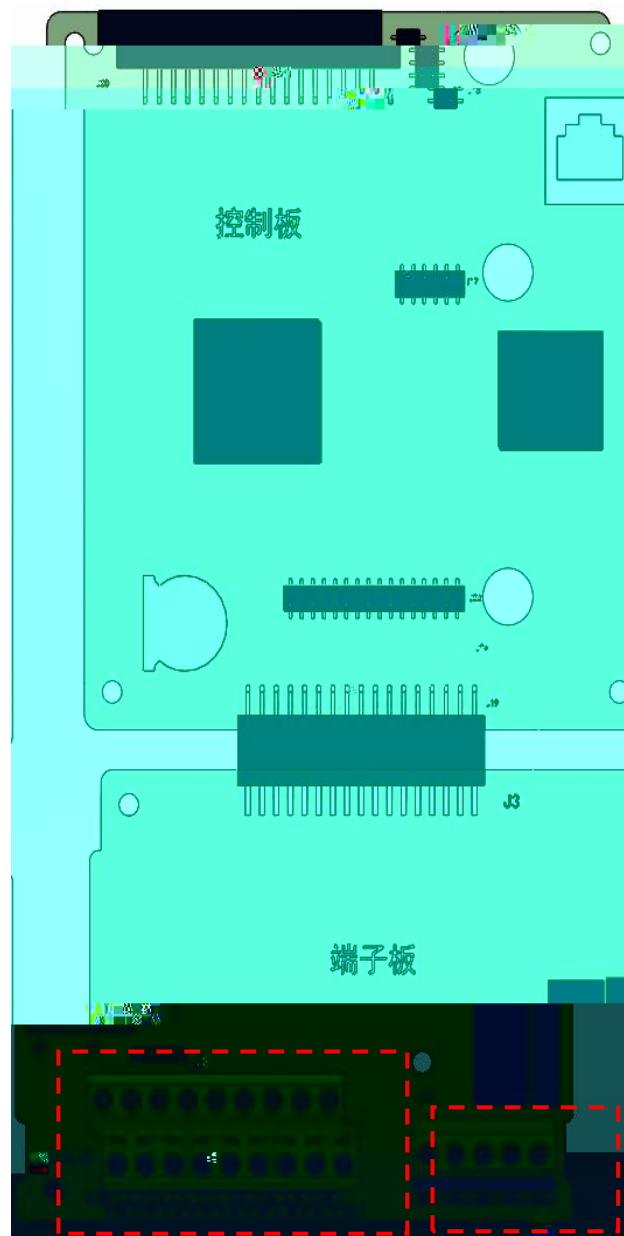

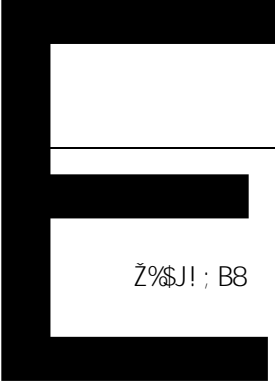

Ž%\$J! ; B8

%\$J

Ž%\$J

) \$a5

%_» !) _»

&(J

Ž&(J

&\$a5



DK

&(J

8=%f8=) 8C%

DK

&(J

87Ž&(J

("

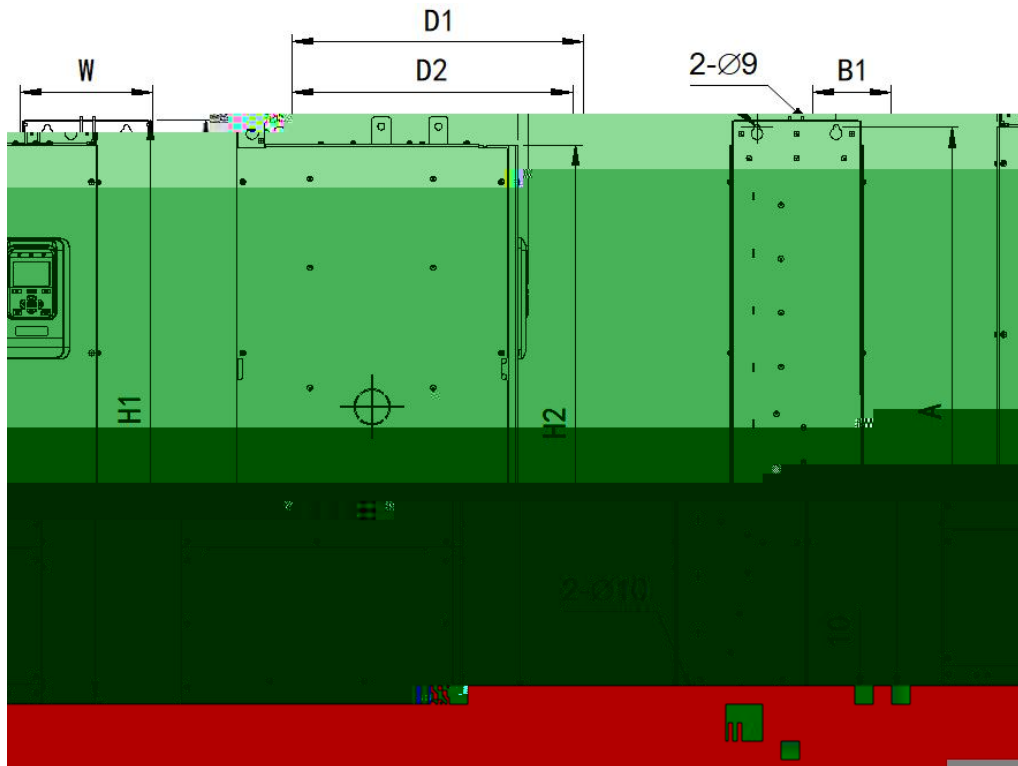

6(

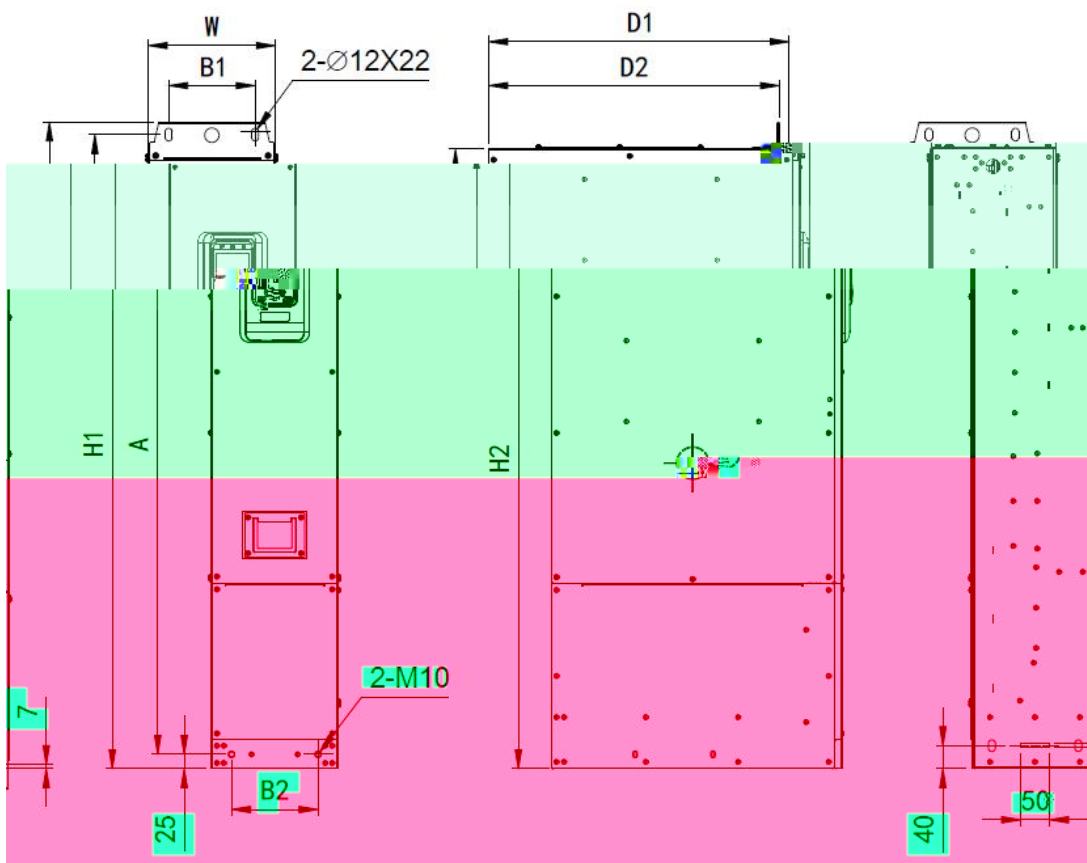

6)

		aa					aa			, ",	┌
		<%	<&	K	8%	8&	5	6%	6&		
<: *, \$B\$- A! %\$\$! (6(- &\$, , \$	&%\$	(*&	(((, --	%&	%& \$	(! A,))
<: *, \$B\$- A! &\$\$! (
<: *, \$B\$- A! &*)! (
<: *, \$B\$- A! ' \$\$! (
<: *, \$B\$- A! (\$\$! (6)	%&&	%\$+)	&&%)&&)\$)	%\$+)	%& \$	%& \$	(! A%\$, \$

)"

)"%

< *, \$B\$-A 87! 87 : %
@C75@#F9ACH9 : & FI B GHCD #F9G9H 9BH9F
87! 87



)"&

9BH9F

F I B G H C D

8787

@C75@#F9ACH9

#

)"'

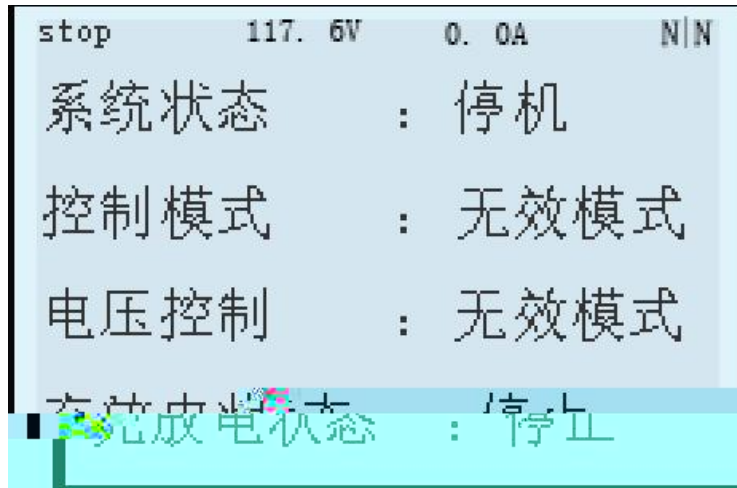

&

p

ghcd WXUF[Y
8]gWXUF[Y

.J

5

p



(
9BH9F Q Q : %#: &

)" (

%	FYZYfYbW GYh	
&	DUfUaYhYf 9X]h	#
,	7i ffYbh 9ffc	
(7i ffYbh KUfb] b[
)	9ffc 9j Ybh @c[f

+ Cdh] cb GYh

,

)	JYfg] cb	
*	8] gd Kcf_ H] aY	

)"("&

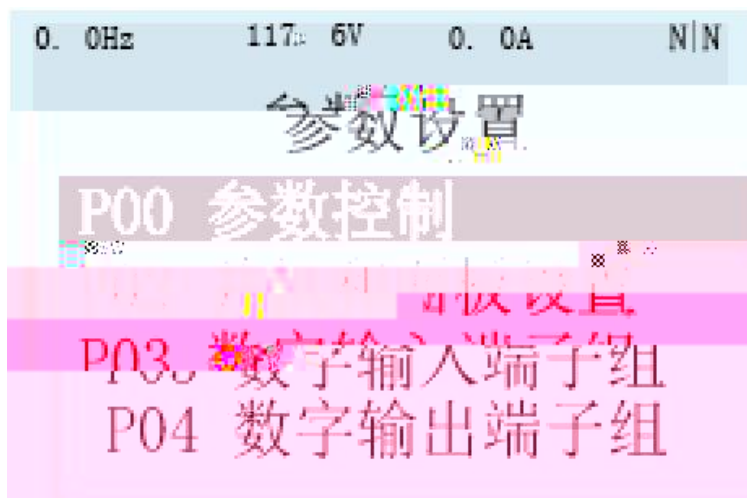

DUFUaYhYf GYhh] b[

)"("'

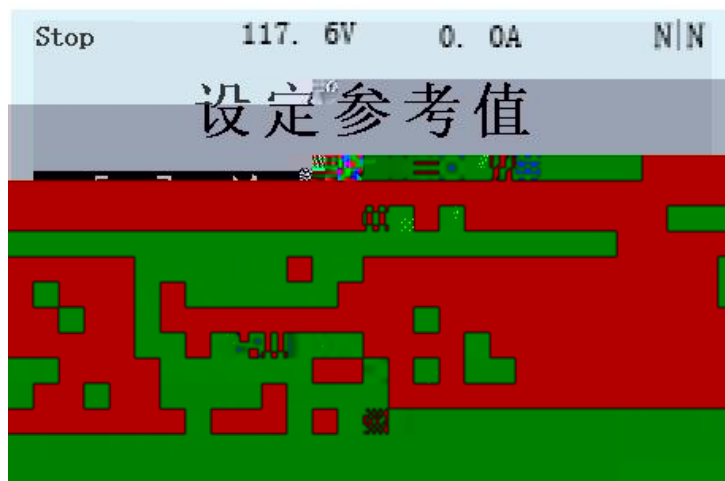

FYZYfYbW GYh

% DufUaYhYf
=b] h] U] nUh] cb

& 8Y` YhY : Ui ` h

, GmghYa FYghUf h

(3 e e
6UW_i d DufU DUX

) FYghcfY DufU DUX
8GD

* 7cadUfY DufU DUX

+ 5Xa] b DUggkcf X j

9bhYf

)"(")

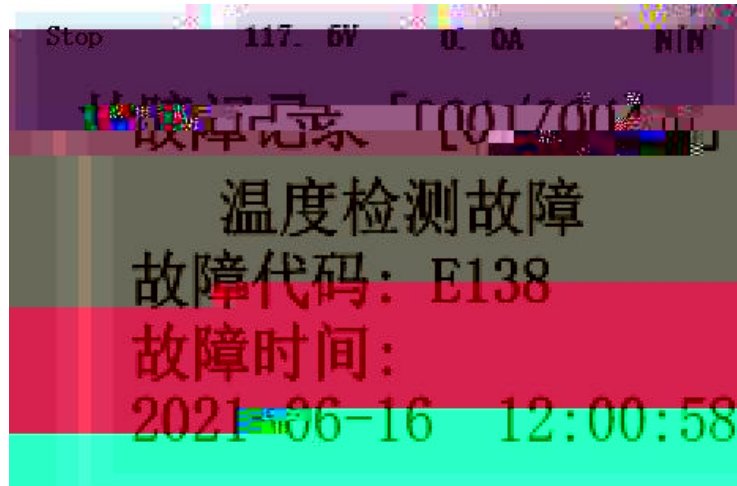

:Ui`h FYWfX

)"("*

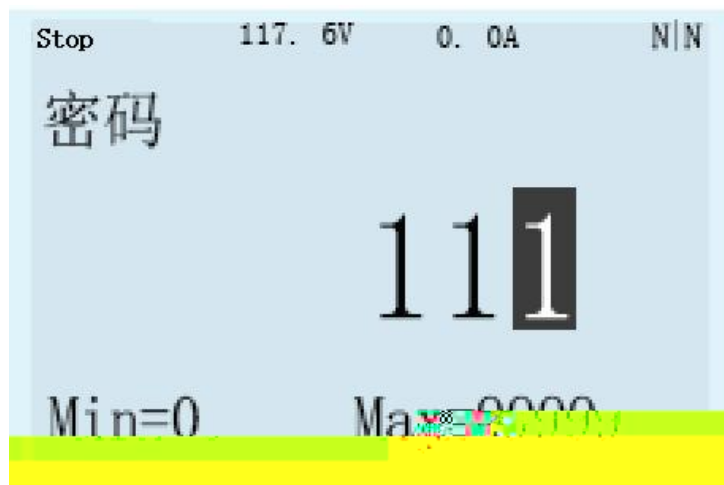

5VVYgg DYfa] gg] cbg

*"

*" %"

8787

D\$- "\$'

8787

% 8787

&" 8787

*" %" %

8787

ž

D- "\$'
8787

O%Q

D- "\$('

O%Q

ž

ž

ž

ž

, _____

D- "\$'
8787

O%Q

D- "\$('

O%Q

ž

ž

ž

ž

, _____

D- "\$'
ž 8787

%

D- "\$('

ž

ž

ž

, _____

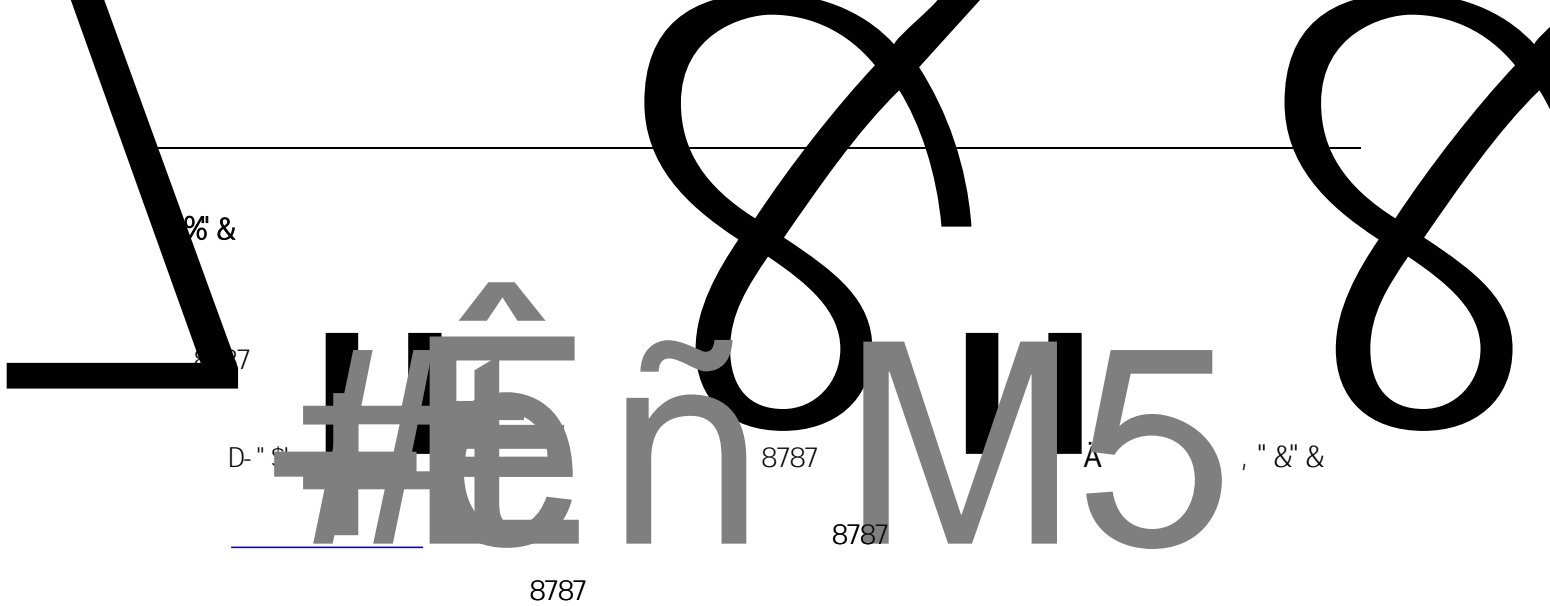

% &

7

D- "\$

8787

A

, " & &

8787

8787

" " "

D\$- " (\$

8787

D\$- " (\$

D\$- "' -

8787

D\$- "' -

*" %'

Y 2 U #

8787

D- "\$

" -

" | &
 ? 1 $\frac{1}{2}$
 D\$% \$ 1 ?

*" &" &

" | %
 " | &
 ? 1 $\frac{1}{2}$
 D\$% && 1 ?

*" &" '

5 " =U%
 5 " =U&
 ?U 1 $\frac{1}{2}$
 D\$% & 1 ?U

6 " =V%
 6 " =V&
 ?V 1 $\frac{1}{2}$
 D\$%' ' 1 ?V

6 " =W%
 6 " =W&
 ?W 1 $\frac{1}{2}$

D\$% (1 ?W

* " " "

8787

8787

* " " "%



D+ " \$\$

(\$\$J

Q, \$\$JQ

D+ " \$%

* * * * *

fl t

D+" %	fl t	fl t O&" \$gQ

* * * * +

D+" &%		O\$Q O%Q
D+" &'		O\$Q O%Q
D+" &(O\$Q O%Q
D+" &)		O\$Q O%Q
D+" &*		O\$Q O%Q
D+" &+		O\$Q O%Q
D+" &,		O\$Q O%Q
D+" &-		O\$Q O%Q

+

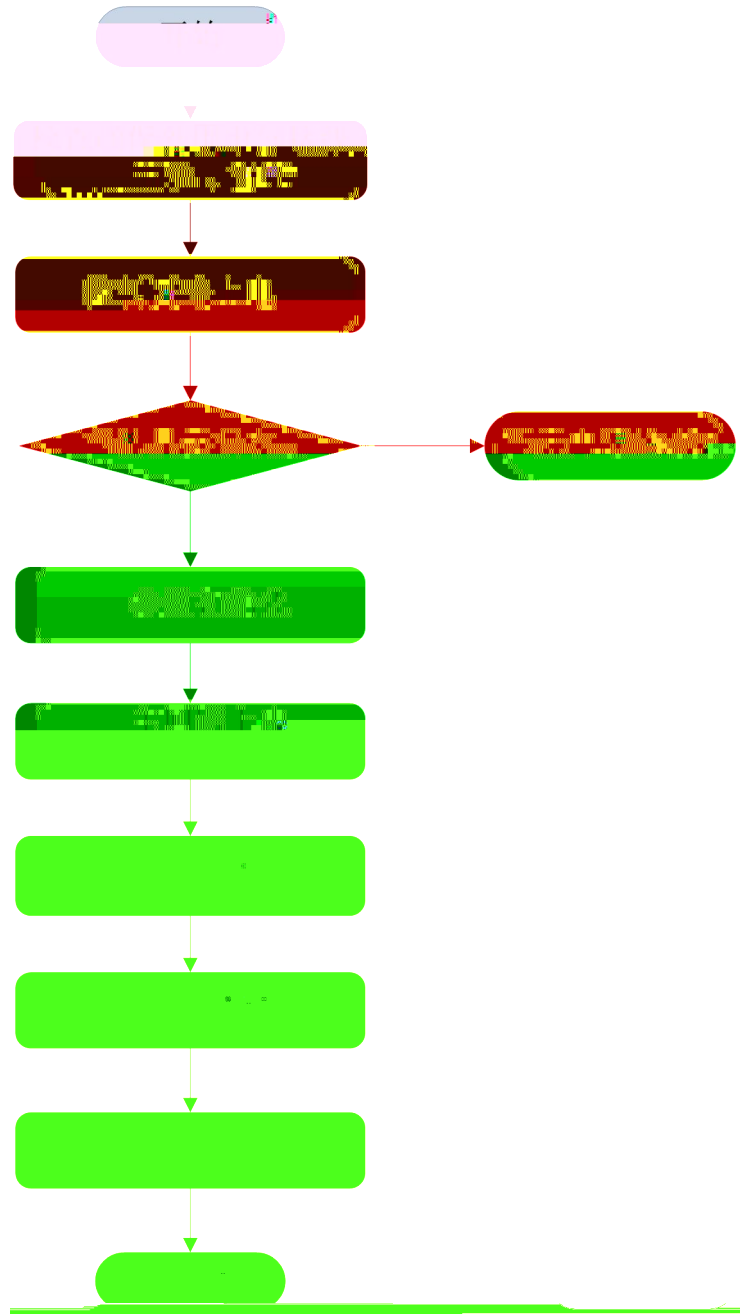

+ "%"

+ "&"

)" (" (_____

ž

ž

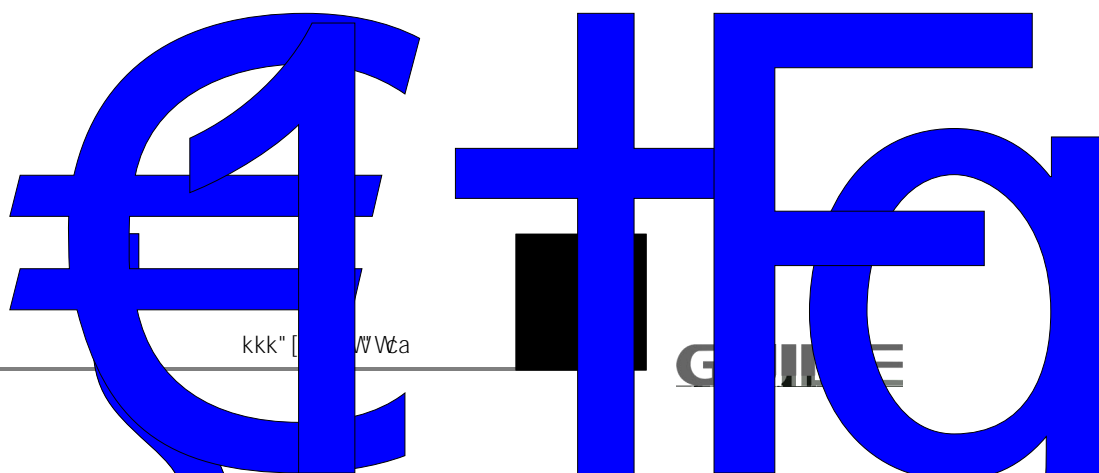
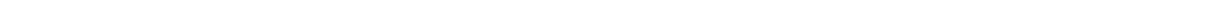

kkk" [Wvta

G M E

\$

D\$-")%

D\$-")% \$ ž D\$- "&% 8W@j b_

D\$-")&

D\$-")& \$ D\$- "&* 8W@j b_

D\$- "&*

D, "\$(\$

D, "\$(\$ \$

)"("'

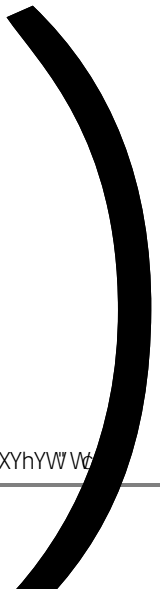

D\$- " (\$

D\$- " (\$ \$

&"

D\$- "' -

8787

D\$- "' -

D\$- "' \$ \$

' "

("

ž

+(" (

D " \$	(%\$ O	Q	
D " \$()	- O	Q	
D(" \$	(, O	Q	
D(" \$()	+ O	Q	
D, " %*		%\$!
D, " %+		&")		!
D+" %+)"\$!
D+" %		&"\$!



		Q	
D- " \$'		% O Q	!
D- " \$(% O Q	!
D ' " "\$	Df cZ] BYh	\$ %	%
D ' " "&%	OK(Q	% O \$Q	
D ' " "&'	OK) Q	% O JQ	

	%	\$	
6] h\$			
6] h%			!
6] h&			!
6] h'			!
6] h(
6] h)			
6] h*	" 5		" 5
6] h+	" 6		" 6
6] h,	" 5		" 5
6] h-	" 6		" 6
6] h%\$!
6] h%%			!
6] h%&			!
6] h%			!
6] h%(!
6] h%&			!

	%	\$	
6] h\$!
6] h%			!
6] h&			!
6] h'			!
6] h(!)			\$\$\$fi \$%fi %\$fi
6] h*! +			\$\$\$fi \$%fi %\$fi %&fi
6] h, ! -			\$\$\$fi \$%fi %\$fi %&fi
6] h%\$!
6] h%%			!
6] h%&			% \$

6] h% ! %			\$\$\$fi \$\$%fi \$%\$fi \$%8fi %\$ \$fi %\$%fi %8\$fi %88fi	D6
-----------	--	--	---	----

OK(Q V] h\$ 1% 8787 V] h\$1\$ 8787
OK) Q \$! %\$\$\$ \$ %\$\$\$

+)" (AcXVi g

AcXVi g

D, " \$\$		' QAC86I GQ	!
D, " \$%		% O Q	!
D, " \$&		% O Q	!
D, " '\$		% O Q	!
D, " \$(' QAcXVi g Q	!
D- " '\$		% O Q	!
D- " \$(% O Q	!

AcXVi g

	%	\$	
6] h\$			
6] h%			!
6] h&	@C75@	F9ACH9	
6] h'	: 5I @HSF9G9H		!
6] h(9LHS: 5I @H		
6] h)	9LHS5@5FA		
6] h*	7hf` AcXY" 5		" 5
6] h+	7hf` AcXY" 6		" 6
6] h,	Jc` h7hf` HmY" 5		" 5
6] h&c` h7hf			

6] h\$ FYUXm
6] h% Fl B Ghc

% \$% 5XXfYgg 1 % \$%

, "

, "%"

, "%" %

6] h*	" 5		" 5
6] h+	" 6		" 6
6] h,	" 5		" 5
6] h-	" 6		" 6
6] h%\$!
6] h%%			!
6] h%&			!
6] h%			!
6] h%(!
6] h%)			!

, " % ' "

	%	\$	
6] h\$!
6] h%			!
6] h&			!
6] h'			!
6] h(!)			\$\$fi
			\$\$fi
			%%fi
6] h*! +			\$\$fi
			\$\$fi
			%%fi
			%%fi
6] h, ! -			\$\$fi
			\$\$fi
			%%fi
			%%fi
6] h%\$!
6] h%%			!
6] h%&		a"	

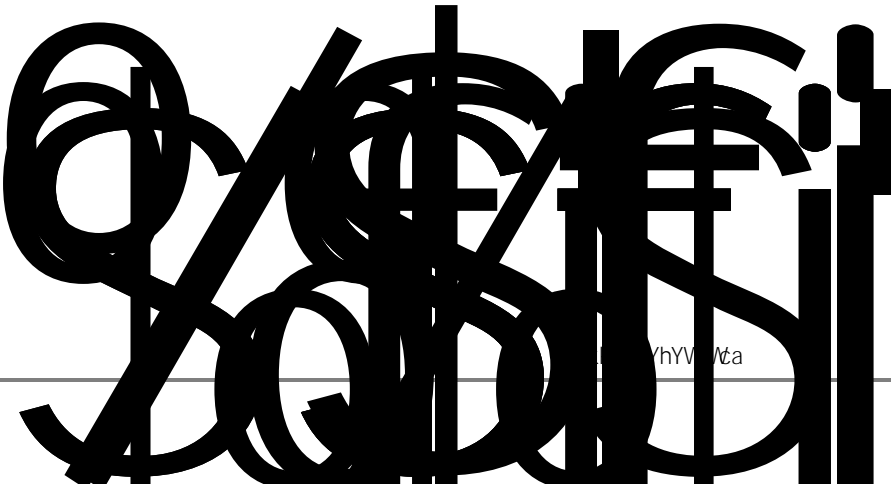

, "% (

V] h% ! %		
\$\$\$fIG%&		G&
\$\$%fIG&&		G
%&%fIG 7		G("
%&%fIG(7		G*
\$\$%fIG) 7		G)
\$\$%fIG* 7		G& G+
%&%fIG+ 7		G&
%&%fIG, 7	D6	DB G, G&

, "&"

, "&" %

D%\$" \$\$

D, " \$%		O\$Q=C O%Q O&QAcXVi g O Q&d
D, " \$&		O\$Q=C O%Q O&QAcXVi g O Q&d
D- " \$'		O\$Q O%Q O&Q O Q
D- " \$(O\$Q O%Q O&Q O Q
D- " \$\$		

)&

		fl t
D, " \$(O\$Q O%Q5=% O&Q5=& O QAcXVi g O(Q8d
D, " \$,		ž /)" \$! #gž

D, " \$(\$

)" ("'

D, " \$%		O\$Q=C O%Q O&QAcXVi g O Q8d
D, " \$&		O\$Q=C O%Q O&QAcXVi g O Q8d
D- " \$'		O\$Q O%Q O&Q O Q
D- " \$(O\$Q O%Q O&Q O Q
D- " \$\$		fl t
D, " \$,		ž /)" \$! #gž
D- " &%	8W @] b_	
D- " &*	8W @] b_	
D- ")%		\$. % AcXVi g & 8d
D- ")&		\$. % AcXVi g & 8d

		O%Q O&Q O Q
D- " \$%		ž
D, " \$(O\$Q O%Q5=% O&Q5=& O QAcXVi g O(Q8d
D, " \$*		\$. D, " \$(%
D, " \$-		/ /)" \$! #gž

D, " \$(O, \$ (L\$ s..

)" (" /

5

D, " \$*

\$

D, " \$(

%

, " " %

, " & "



D, " \$%

Σ

BOVA

HOZAVI ā

MI

\$ \$ %

Σ s..

e &

kkk" [XYhV Wta

GUIDE

))

		QCBd
D, "\$-		/)" \$! #gž

D, "\$(
\$
)" (" /

D, "%& 1&

D, "%& 1'

, \$l

, " " "

, " " "%

8787

8787

, " (% AcXVi g

AcXVi g

D' & "\$%	AC861 G =8	A] b1% AUI 1&)) %
D' & "\$&	AC861 G	O\$Q FG(,) / O%Q FG&' & FG(,)
D' & "\$'	AC861 G	O\$Q - *\$\$ 6DG O%Q % (\$\$ 6DG O&Q % &\$\$ 6DG O Q ' , (\$\$ 6DG O(Q) *\$\$\$ 6DG O) Q) +*\$\$ 6DG O*Q %88 &\$\$ 6DG
D' & "(O\$Q BcbYS, S%\$7: ; O%Q 9j YbS, S%\$7: ; O&Q CXXS, S%\$7: ; O Q BcbYS, S&\$7: ; O(Q 9j YbS, S&\$7: ; O) Q CXXS, S&\$7: ;
I G		AC86

AcXVi g

\$) <

acXVi g %\$			F#K
\$		\$. %	K
%			!
&		%	K
'		%	K
(\$ %	K
)		\$ %	K
*	" 5	\$\$.	K
+	" 6	\$\$ %\$.	K

*\$

		%%	
,	" 5	\$. \$%	K
-	" 6	%. %%	K
%%! %			!

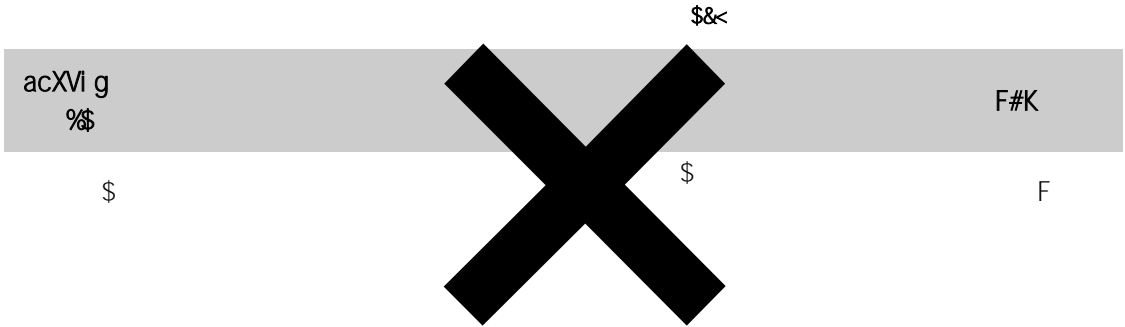

7

-

æ

" i

acXVI g %\$				F#K
\$	8=		8=	F
)\$		%QJO	%%\$ 12 % \$QJOž !%\$ r Ž%\$QJO	F
)%		%O=O	%%\$ 12 %Qa5Qž \$ r &\$Qa5Q	F
)&		&QJO	%%\$ 12 % \$QJOž !%\$ r Ž%\$QJO	F
)'		&O=O		

%&	6		%\$12%\$ " \$5	F
%	7		%\$12%\$ " \$5	F
%+			%\$12%\$ " \$J	F
%			%\$12%\$ " \$J	F
%			%\$12%\$ " \$	F
&%			%\$12%\$ " \$i	F
&&			%\$12%\$ " \$i	F
&			%\$12%\$ " \$i	F
) \$	5C%	%	%\$ 12 % \$Q Q	F#K
) %	5C&	&	%\$ 12 % \$Q Q	F#K
* \$			O\$+" " \$\$Q . O% " " \$, Q .	F
* &			O\$+" " \$\$Q . O% " " \$, Q .	F
%\$\$		O\$ " % Q	%\$ 12 % \$i	F#K
%\$%		\$ " %Q	%\$ 12% " \$J	F#K
%\$&		\$ " %	%\$ 12% " \$i	F#K
%\$'		\$ " %	%\$ 12% " \$5	F#K
%\$(:		\$ " %		F#K
%\$)				

, " (" & DB

8787 DB DB " DB ž
DB 8787

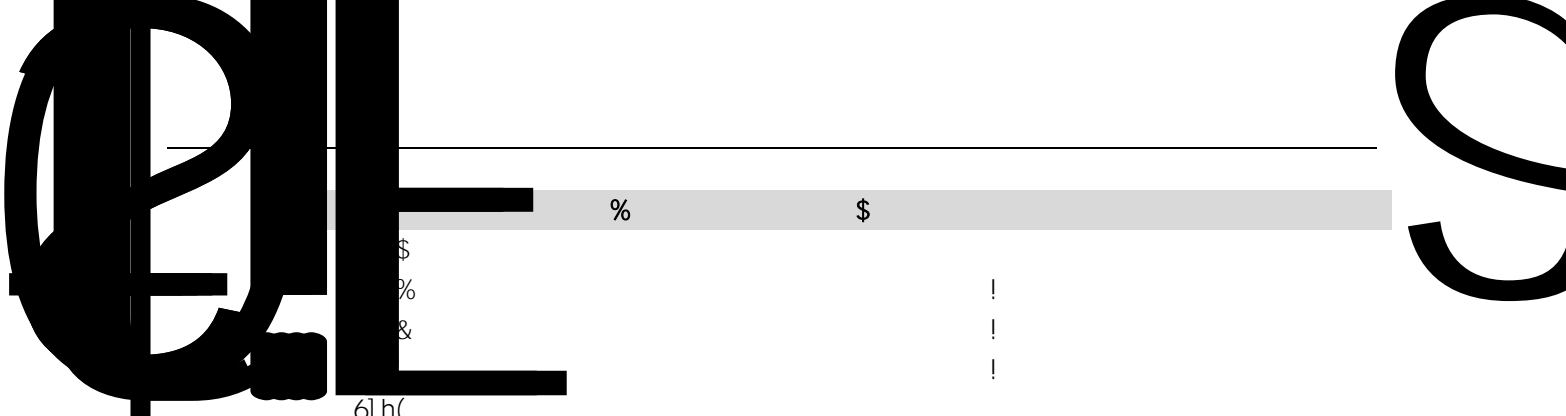

6] h(
6] h)
6] h*

%

\$

!
!
!

" 5

\$\$fi



\$



k " [XYhYWWta

GUIDE

*)

			%\$%fi %\$%fi %\$%fi D6
--	--	--	-------------------------------

8787

8787

8787

- "

- "%

8787
AcXVi g

D\$

D&

D'

D(

D)

D*

D+

D,

D- 8787

D%\$

D' & AcXVi g

%		
'	" U	% \$ \$\$
(" V	\$% %\$ %%
)	" U	% \$ \$\$
*	" V	\$% %\$ %%
+		
,		
-		
%\$		
%%		
%&	" B7	
%	: I B7 %&	
%{	: I B7 %	
%}	: I B7 %{	
%*	: I B7 %}	

- " & "

D(

D(" \$	%		\$ %}	\$
D(" %	&		\$ %}	\$
D(" &	'		\$ %}	\$
D(" "	(\$ %}	\$
D(" ()		\$ %}	\$

\$		
%		
&		CB
'		

*

D) " *	5=%	5=%	! ' \$\$\$ \$ ' \$\$\$ \$ Q Q	\$" \$ Q Q
D) " +	5=%	5=%	! %\$" \$\$ %\$" \$\$ QJQ	%\$" \$\$\$ QJQ
D) " ,	5=%	5=%	\$" \$\$ &\$" \$\$ Qa5Q	&\$" \$\$\$ Qa5Q
D) " -	5=%	5=%	! ' \$\$\$ \$ ' \$\$\$ \$ Q Q	%\$"\$ \$ Q Q
D) " %	5=&	O\$Q O%Q\$ Z%\$J O&Q %\$ Z%\$J O Q\$ &\$a5	\$ '	'
D) " %	5=&	5=&	\$" \$ %\$"\$ \$ QagQ	&)" \$ QagQ
D) " &\$	5=&	5=&	! %\$" \$\$ %\$" \$\$ QJQ	\$" \$\$\$ QJQ
D) " &%	5=&	5=&	! &\$" \$\$ &\$" \$\$ Qa5Q	\$" \$\$\$ Qa5Q
D) " &&	5=&	5=&	! %\$" \$\$ %\$" \$\$ QJQ	\$" \$\$\$ QJQ
D) " &'	5=&	5=&	\$" \$\$ &\$" \$\$ Qa5Q	\$" \$\$\$ Qa5Q
D) " &(5=&	5=&	! ' \$\$\$ \$ ' \$\$\$ \$ Q Q	\$" \$ Q Q
D) " &)	5=&	5=&	! %\$" \$\$ %\$" \$\$ QJQ	%\$" \$\$\$ QJQ
D) " &*	5=&	5=&	\$" \$\$ &\$" \$\$ Qa5Q	&\$" \$\$\$ Qa5Q
D) " &+	5=&	5=&	! ' \$\$\$ \$ ' \$\$\$ \$ Q Q	%\$"\$ \$ Q Q

- "&" (Ê e

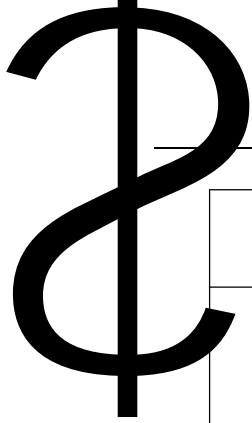

D*" &%	5C&	5C& 0% Q	fID*" % t	"\$ \$ %\$\$" \$ Q Q	"\$ \$ Q Q
D*" &&	5C&		5C%	"\$ \$ %\$\$" \$ QaQ	"\$ \$ QaQ

+! %

\$		
%		
&		
'		fl t
(fl % \$ t
)	8D	Df cZ] Vi g
*		D*" + D*" &%
+		

- " &")

D+



D+" \$\$	*\$\$, &\$, \$\$
	QIQ	QIQ
D+" \$%	' \$\$) \$\$	') \$ \$
	QIQ	QIQ
D+" \$&		



- "&" *

D,

D, " \$\$		O\$Q O%Q O&O8d O QAC86l G O(Q	\$ (%
D, " \$%		O\$Q=C O%Q O&OAcXVI g O Q8d	\$ '	%
D, " \$\$		O\$Q=C O%Q O&OAcXVI g O Q8d	\$ '	%
D, " \$'		O\$Q fl t O%Q	\$ %	%
D, " \$(O\$Q O%Q5=% O&Q5=& O QAcXVI g O(Q8d	\$ (\$
D, " \$*		\$. D, " \$(%	\$ %	\$
D, " \$,			\$" \$ ' \$\$\$ \$ Q #gQ)" \$ Q #gQ
D, " \$-			\$" \$ ' \$\$\$ \$ Q #gQ)" \$ Q #gQ
D, " %%		O\$Q O%Q	\$ %	%
D, " %&		O\$Q O%Q O&Q O Q , \$l	\$ '	'
D, " %		D, " %&1% D, " %	\$ ' \$\$ Q Q	-\$ Q Q
D, " %<			\$" \$%)" \$\$\$ OgQ	\$" % OgQ
D, " %>			\$" \$%)" \$\$\$ OgQ	\$") OgQ
D, " %*			\$" % * \$\$\$ \$ OgQ	% OgQ
D, " %+			\$" % %\$ \$ OgQ	&") OgQ



		% 9j YbS, S%\$7: ; & CXXS, S%\$7: ; ' BcbYS, S&\$7: ; (. 9j YbS, S&\$7: ;) . CXXS, S&\$7: ;		
D' &" \$)			\$ž %\$\$ OgQ	\$ OgQ

- " &" %\$

D' '

D' '\$	Df cZ] Vi g	O\$Q O%Q	\$ %	\$
D' "%		D@7	% &)	%
D' "&		O\$ODDC % O%ODDC & O&ODDC) O Q I =89	\$ '	&
D' '''			\$ %*	%
D' '(\$ %*	%
D' ')		O\$Q O%Q O&Q O Q		

		O(Oy %\$\$\$\$			
D' "'%+	OK&Q	+! &	\$ ' ,	\$	
		O\$OyC% ž a" S	c	%	
		O%Oy %\$ a" R			
D' "'%	OK&Q	O&Oy %\$\$	\$ (\$	
		O' Oy\$\$\$\$ž a" X			
		O(Oy\$\$\$\$\$ c	\$		
D' "'%	OK' Q	+! &	\$ ' ,	\$	
		O\$Oy %			
		O%Oy %\$			
D' "'&\$	OK' Q	O&Oy %\$\$	\$ (\$	
		O' Oy %\$\$\$			
		O(Oy %\$\$\$\$			
D' "'&%	OK(Q	+! &	\$ ' ,	%	
		O\$Oy %			
		O%Oy %\$			
D' "'&&	OK(Q	O\$Oy %\$\$\$	\$ " %	\$	
		O(Oy %\$\$\$			
		O(Oy %\$\$\$\$			
E, " %&	OK(Q	+! &	\$ ' ,	%	
D' "'&					
O, %&&	OK((%	€ ∑ g.. €	€	∑ .. 69
D' "'%		€€€ €€€€			
	dO K	€€	CC	.. " %	€
		€	"	€	"
		eO zO	C		∞
		, %			
	H O	€€€	C	€	
		i %			
		€€€			
		€			
		x€€ ∑ g.. C'	CC		

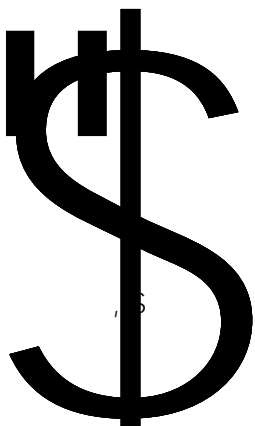

		$O \& Q_y \text{ } \%\$$ $O Q_y \text{ } \%\$\$\$$ $O(Q)_y \text{ } \%\$\$\$\$$		
$D' \text{ } \text{ } (-)$	$OK\$Q$	$+!'$	$\$ (,$	$\$$
$D' \text{ } \text{ } (*$	$OK\$Q$	$O\$Q_y \text{ } \%$ $O\%Q_y \text{ } \%\$$ $O\&Q_y \text{ } \%\$\$$ $O Q_y \text{ } \%\$\$\$$ $O(Q)_y \text{ } \%\$\$\$\$$ $O) \text{ } \text{ } Q_y \text{ } \%$ $O^* \text{ } \text{ } Q_y \text{ } \%\$$ $O+ \text{ } \text{ } Q_y \text{ } \%\$\$$	$\$ +$	$\$$
$D' \text{ } \text{ } (+$	$OK\%Q$	$+!'$	$\$ (,$	$\$$
$D' \text{ } \text{ } (,$	$OK\%Q$	$O\$Q_y \text{ } \%$ $O\%Q_y \text{ } \%\$$ $O\&Q_y \text{ } \%\$\$$ $O Q_y \text{ } \%\$\$\$$ $O(Q)_y \text{ } \%\$\$\$\$$ $O) \text{ } \text{ } Q_y \text{ } \%$ $O^* \text{ } \text{ } Q_y \text{ } \%\$$ $O+ \text{ } \text{ } Q_y \text{ } \%\$\$$	$\$ +$	$\$$
$D' \text{ } \text{ } (-$	$OK\&Q$	$+!'$	$\$ (,$	$\$$
$D' \text{ } \text{ })\$$	$OK\&Q$	$O\$Q_y \text{ } \%$ $O\%Q_y \text{ } \%\$$ $O\&Q_y \text{ } \%\$\$$ $O Q_y \text{ } \%\$\$\$$ $O(Q)_y \text{ } \%\$\$\$\$$ $O) \text{ } \text{ } Q_y \text{ } \%$ $O^* \text{ } \text{ } Q_y \text{ } \%\$$ $O+ \text{ } \text{ } Q_y \text{ } \%\$\$$	$\$ +$	$\$$
$D' \text{ } \text{ })\%$	$OK' Q$	$+!'$	$\$ (,$	$\$$
$D' \text{ } \text{ })\&$	$OK' Q$	$O\$Q_y \text{ } \%$ $O\%Q_y \text{ } \%\$$ $O\&Q_y \text{ } \%\$\$$ $O Q_y \text{ } \%\$\$\$$ $O(Q)_y \text{ } \%\$\$\$\$$ $O) \text{ } \text{ } Q_y \text{ } \%$ $O^* \text{ } \text{ } Q_y \text{ } \%\$$ $O+ \text{ } \text{ } Q_y \text{ } \%\$\$$	$\$ +$	$\$$
$D' \text{ } \text{ })'$	$OK(Q$	$+!'$	$\$ (,$	$\%$
$D' \text{ } \text{ })(\$		$O\$Q_y \text{ } \%$ $O\%Q_y \text{ } \%\$$	$\$ +$	$\$$



D' ''*'

OK-Q

+''

\$ (,

%

OSQy %

D' ''*(

OK-Q

&&	0?kQ
&	Q Q
&(05Q
&)	05Q
&*	05Q
&+	%Q Q
&	&Q Q
&-	Q Q
' \$	Q Q
' %	Q]Q
' &	Q]Q
' '	Q]Q
' ('	Q]Q
')	%Q]Q
' *	&Q]Q
' +	%Q]Q
' ,	&Q]Q

+!'

\$	
%	\$
&	%
'	&
('
)	(
*)
+	\$ ' &]h
,	% ' &]h
-	& ' &]h
;%	' ' &]h
%%	(' &]h
%&) ' &]h
% ! %*	
%+	
%	
%	
&\$	
&%	5
&&	
&	?k
&(5
&)	6
&*	7
&+	5



%\$"

%\$ %

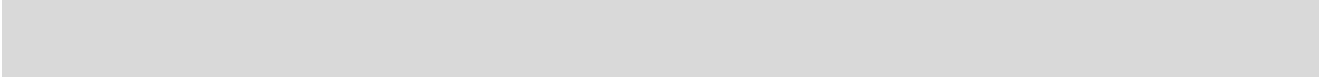

K\$%

GM&SBCHSF8M fIFYUXmt

K&)) G@) S75BS9FF))

%\$" &



09\$) \$Q I =; 6H
 9FFSI H bch fYgYh =; 6H

09\$) &Q J =; 6H
 9FFSI H bch fYgYh =; 6H

09\$) (Q K =; 6H
 9FFSI H bch fYgYh =; 6H

09\$*) Q 8C
 8C
 8787 8C
 8787 8=



09\$**Q 8C
 8C
 8787

09&&\$Q	7F7 A9ACFM 7F7 9FF	
09&&%Q	D5F5A9H9F 9FFCF	

%\$'



87&(J

8C

8C

8C

CB

7CA

CB

7CA

%'

%'

%&

	% &	% 2 (\$ 0 -) I &
	% &	% &
	% & ' "	% & ' "
	% &	% &

%'

87! 87

		% &
D76	&	

GUIDE

% 87! 87

&

,

Ki \Ub ; i] XY HYW\bc` c[m 7c" ž@hX"

*

(' \$&&'

, *! \$&+! , +- &+&' \$

g\Zk4[XYhYW\Wca

kkk" [XYhYW\Wca

(\$\$! \$\$++!) +\$