

GF 630N01

1. 01

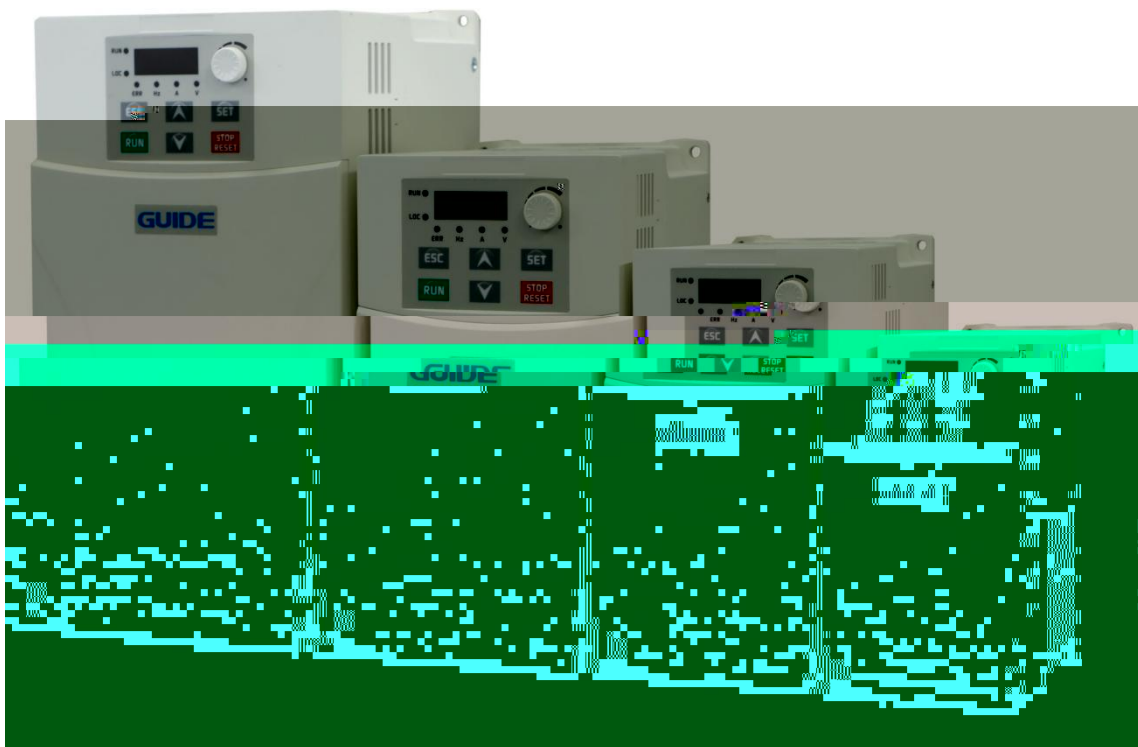













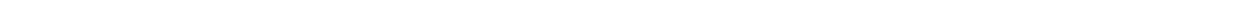





	.....	1
	.....	1
	.....	3
	.....	5
	.....	7
	.....	7
	.....	9
	.....	9
	.....	10
	.....	11
	.....	11
	.....	12
	.....	13
	.....	13
	.....	15
	.....	15
	.....	17
	.....	17
	.....	18
	.....	18
	.....	18
	.....	18
	.....	19
	.....	22
3.3.1	.....	23
3.3.2	.....	24
	.....	26
	.....	26
	.....	29
	.....	30
	.....	31
	.....	31
	.....	33
	.....	33
	.....	33
	.....	34
	.....	34
	.....	35
	.....	37
	.....	37
	.....	37
	.....	43
	.....	43
	.....	44
	.....	44
	.....	45
	.....	46

.....	49
.....	50
.....	50
.....	53
.....	55
.....	57
.....	58
.....	59
.....	64

---





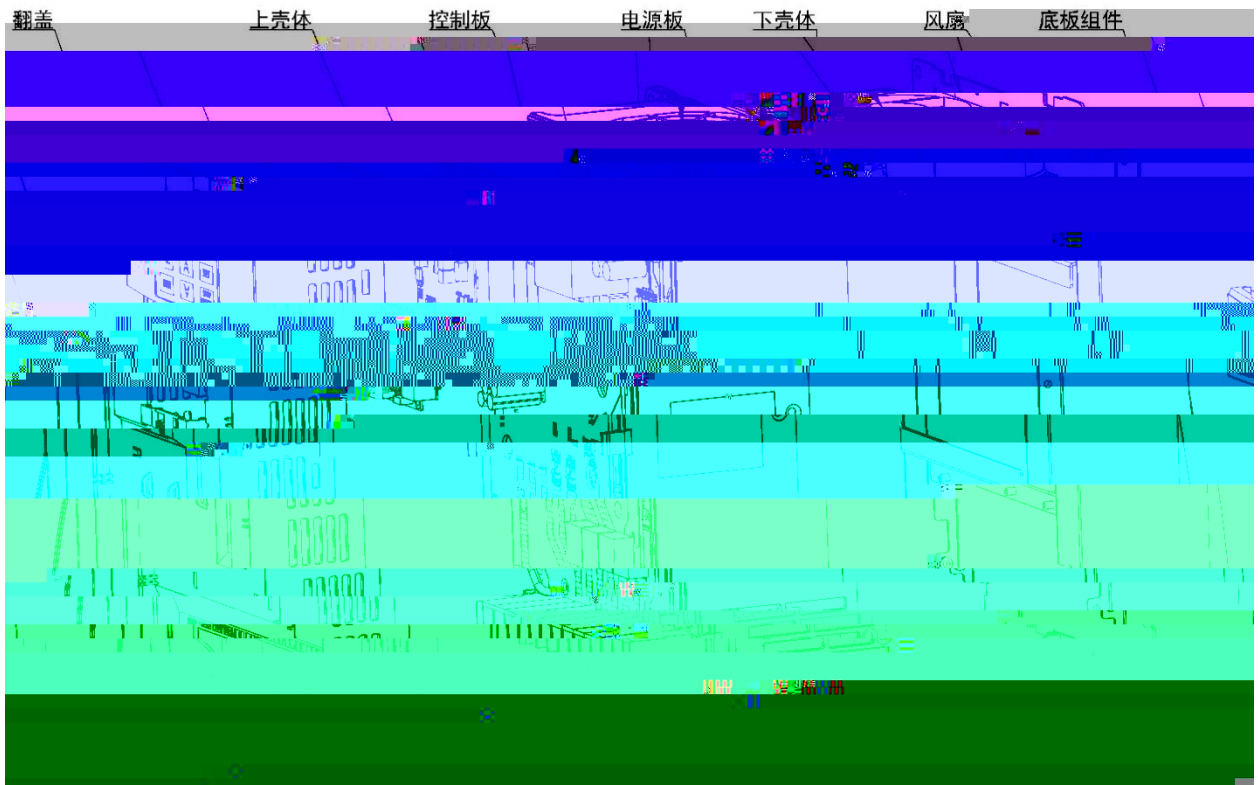

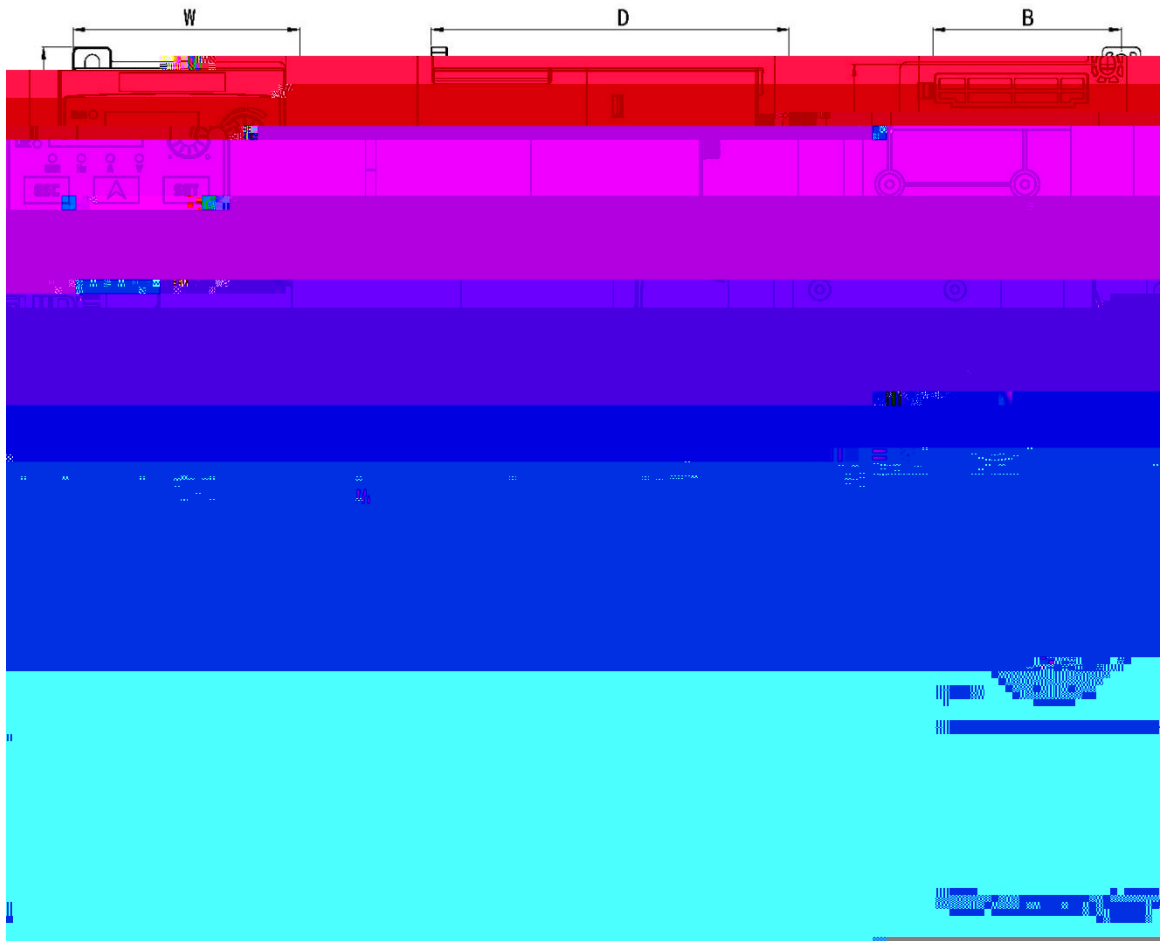

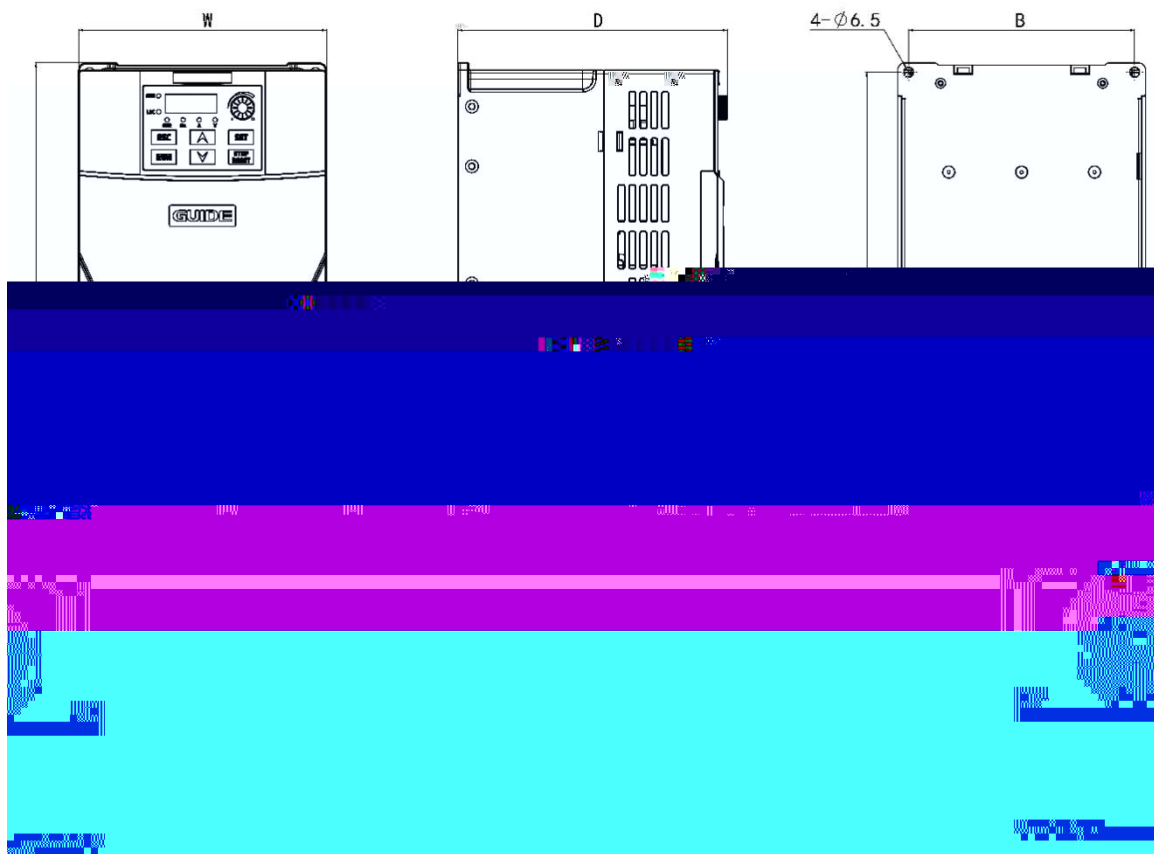

---





---

AC380V

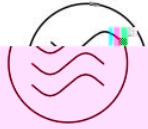

GF630N01系列变频器



断路器



熔断器



GUIDE

接触器



输入

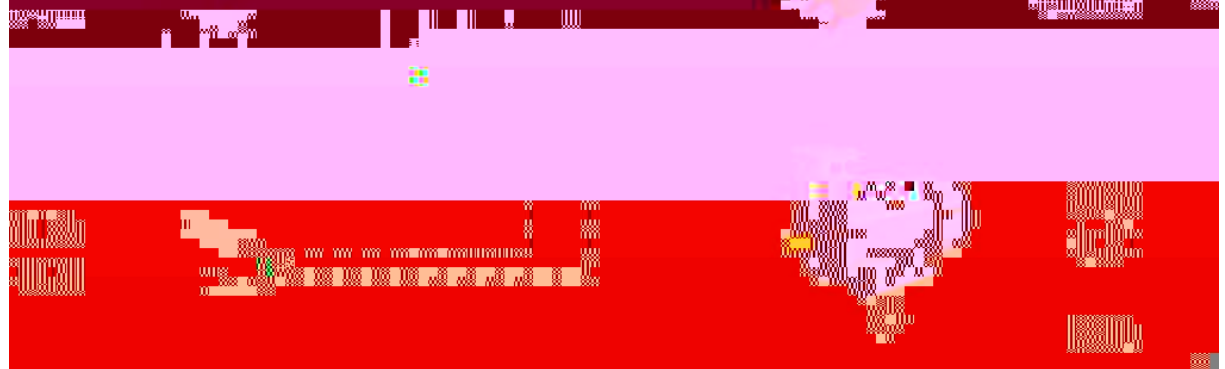





---



---



~~XXXXXXXXXXXXXXXXXXXX~~



~~XXXXXXXXXXXX~~



~~XXXXXXXXXXXX~~





---

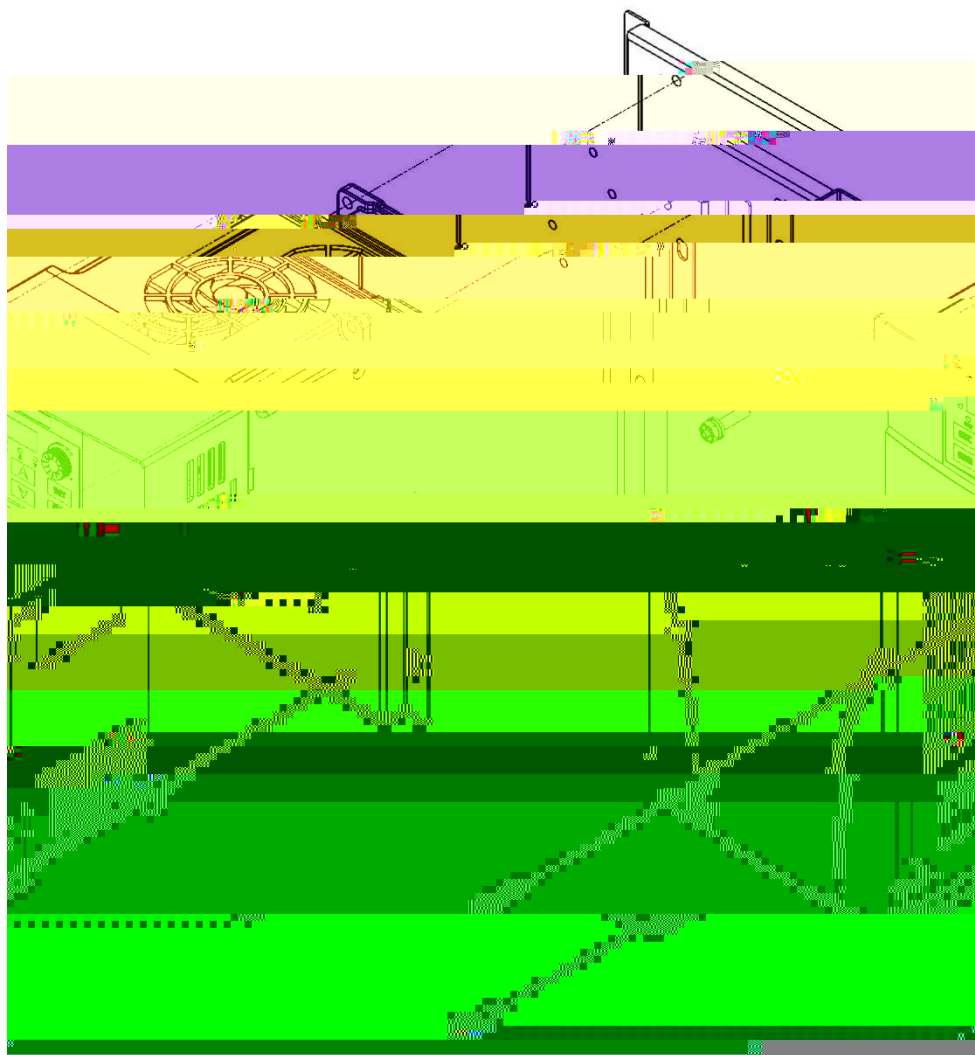

---

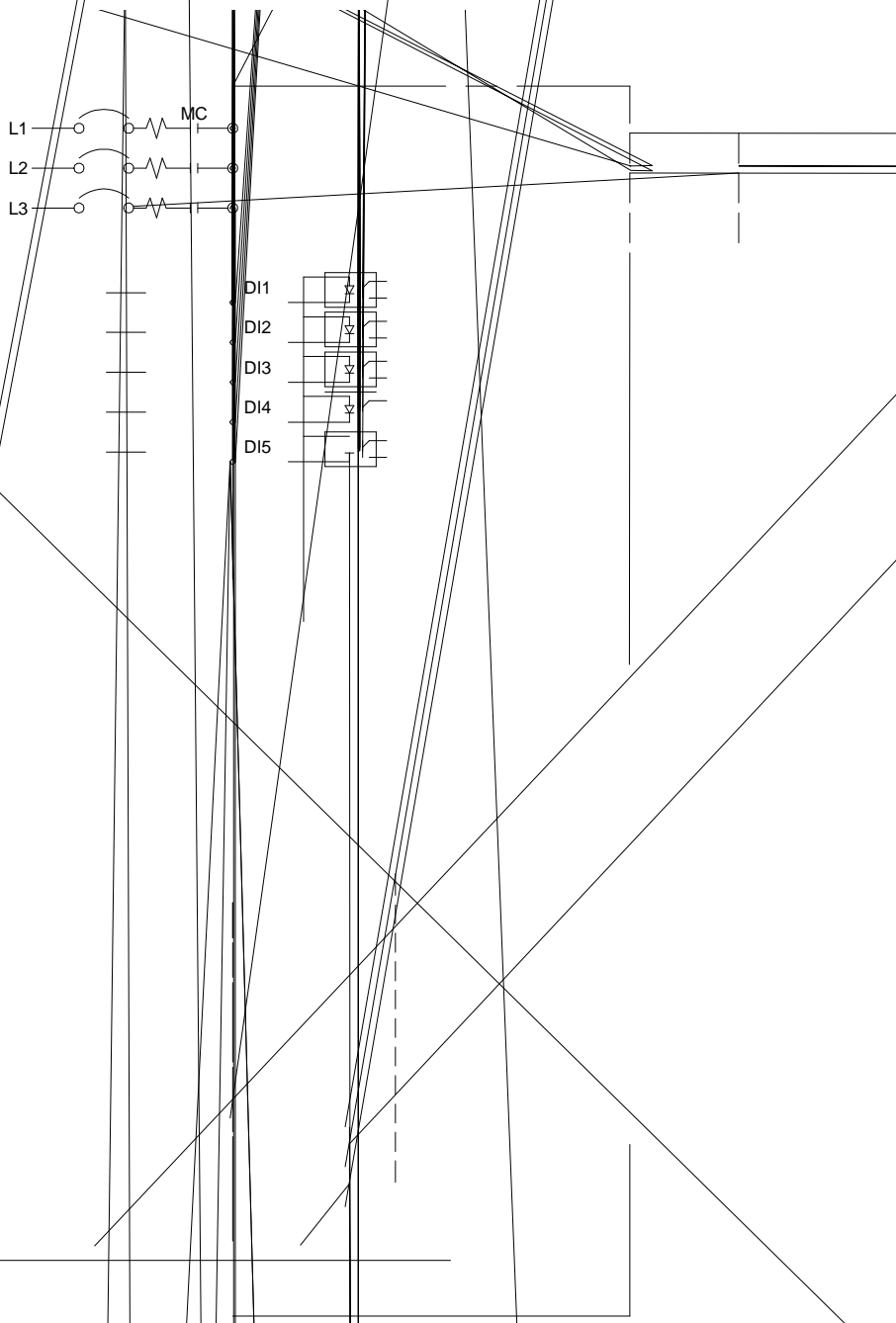

3.3.1

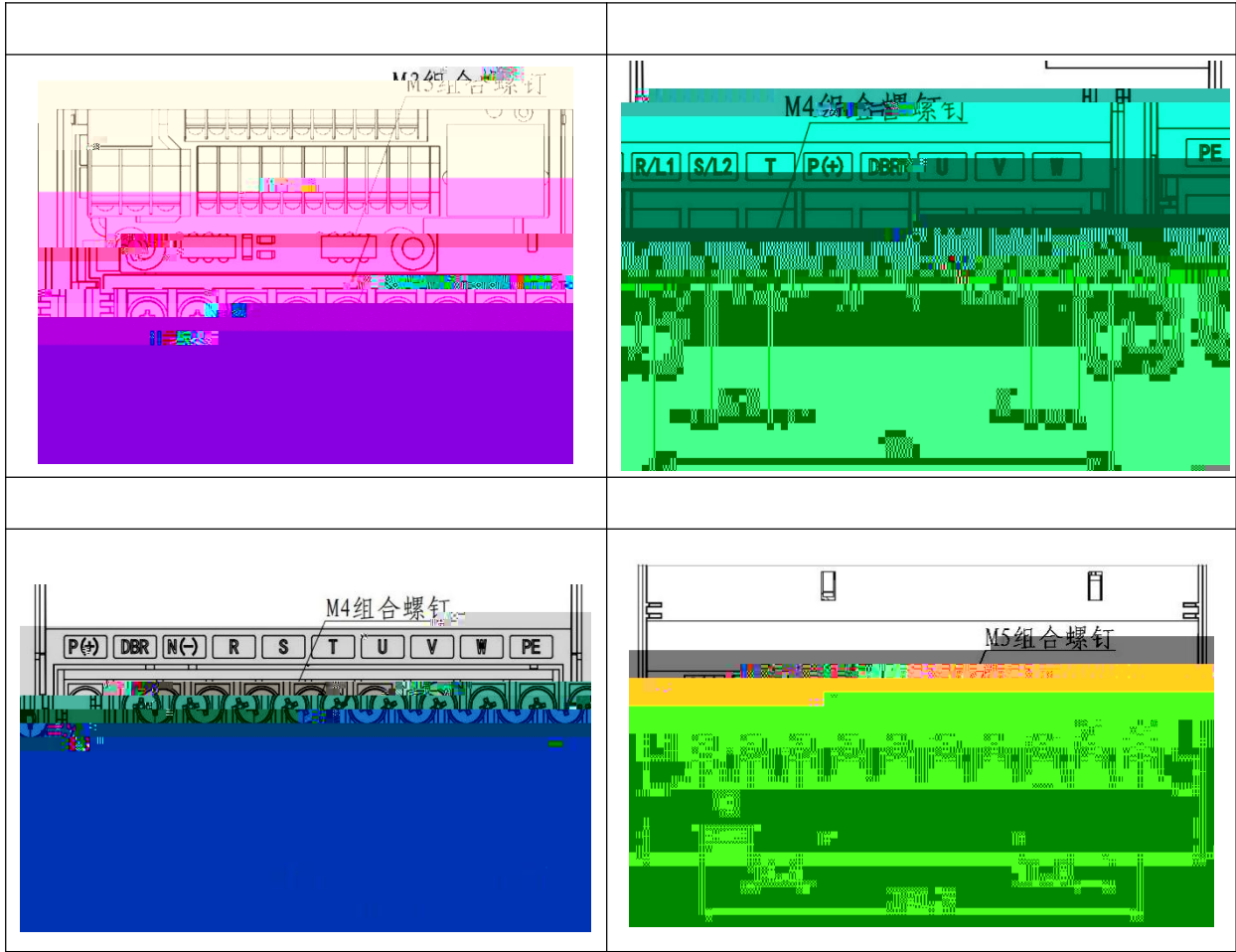

3. 3. 1

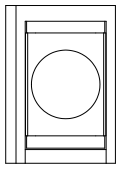

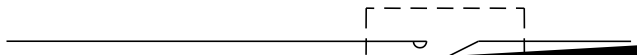

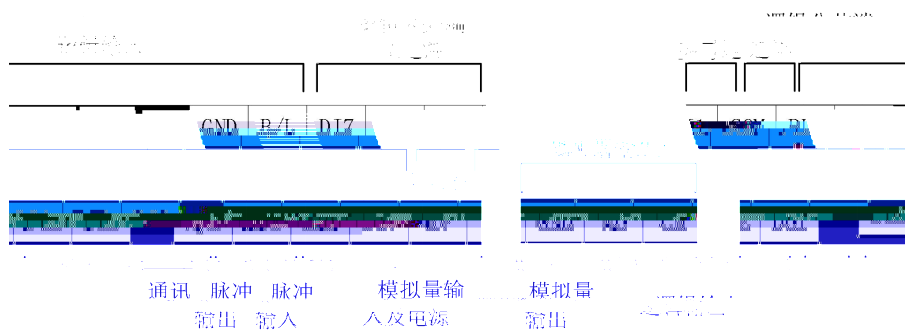
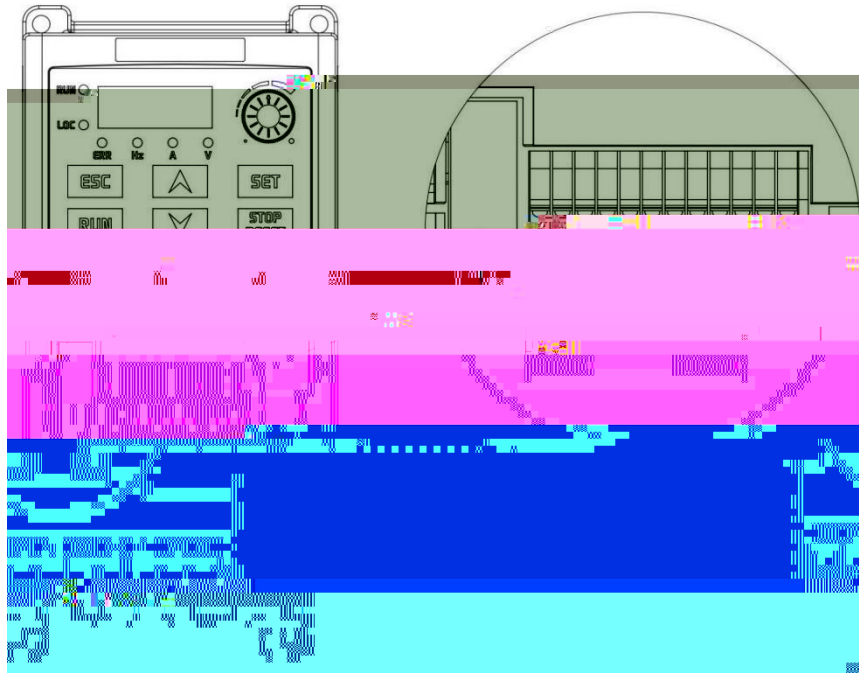

模拟量输入

模拟量输出



---



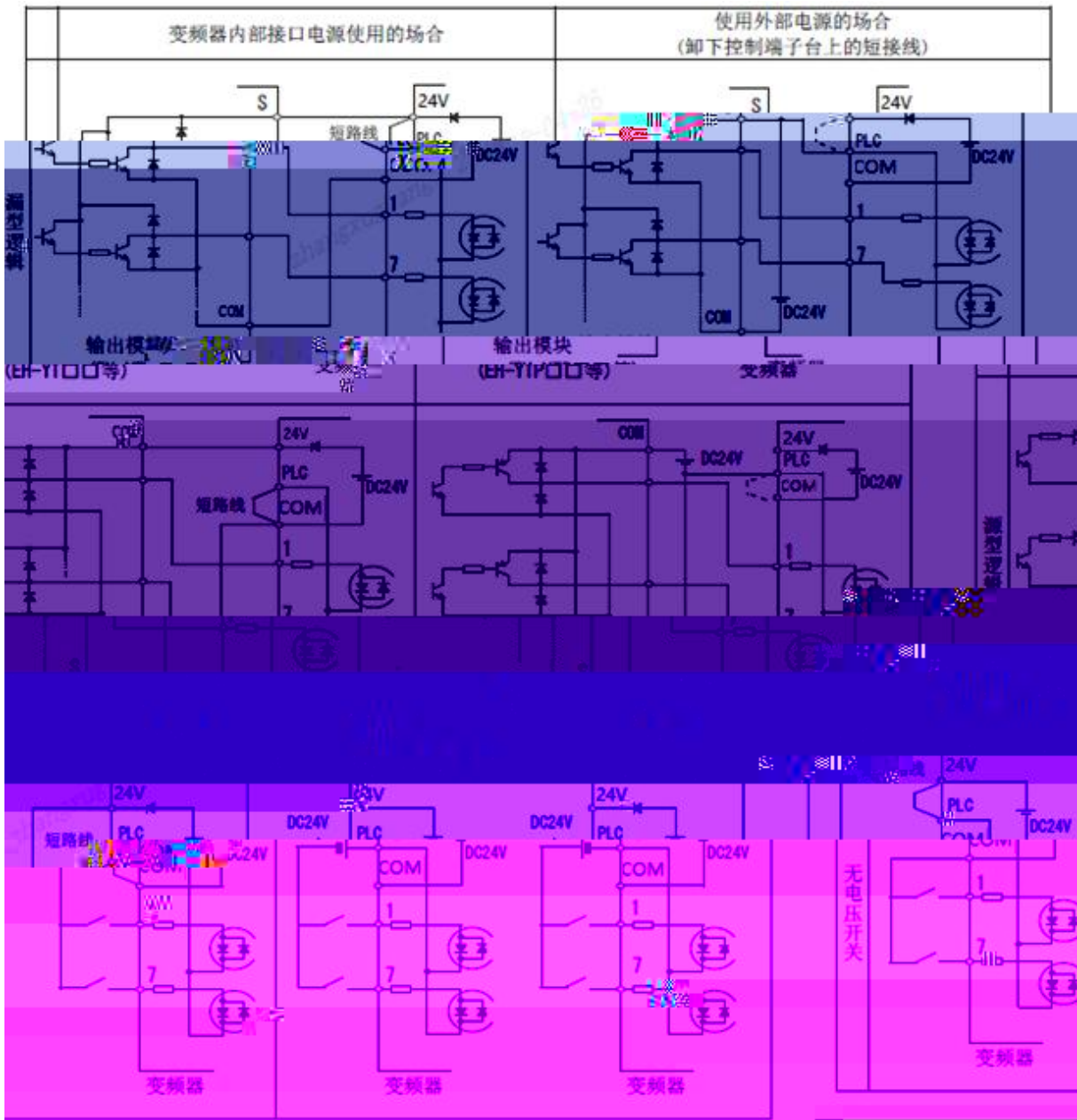
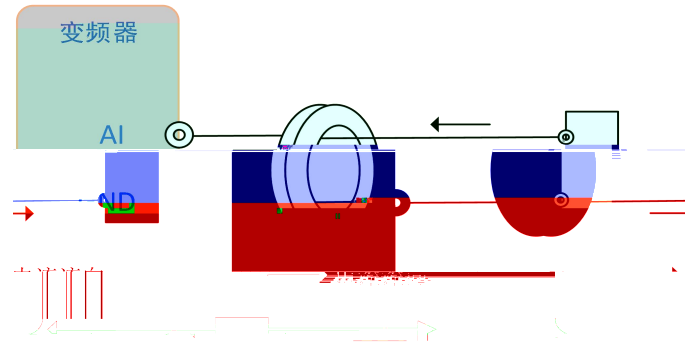

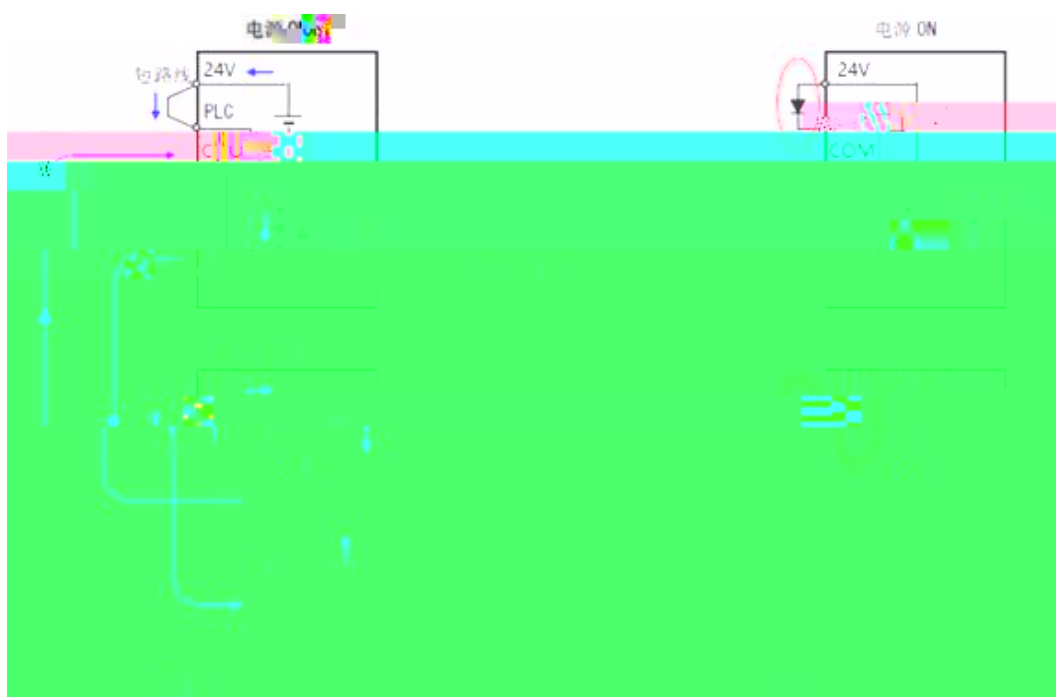

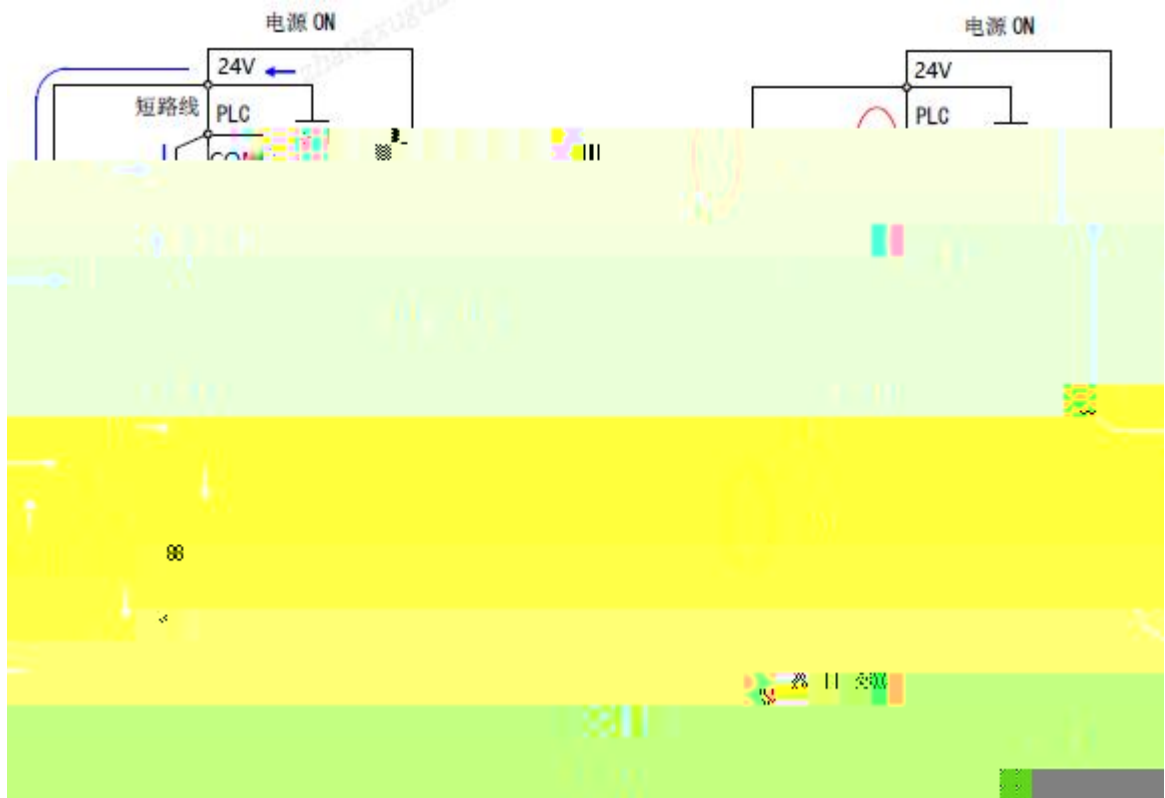



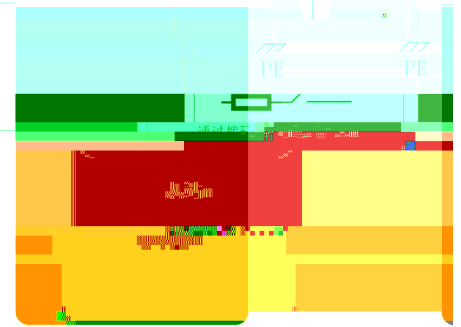
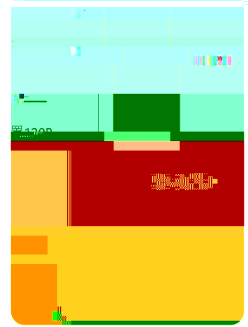
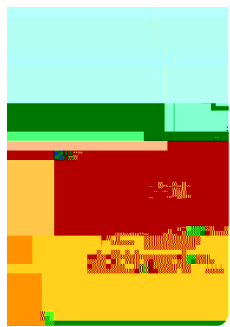
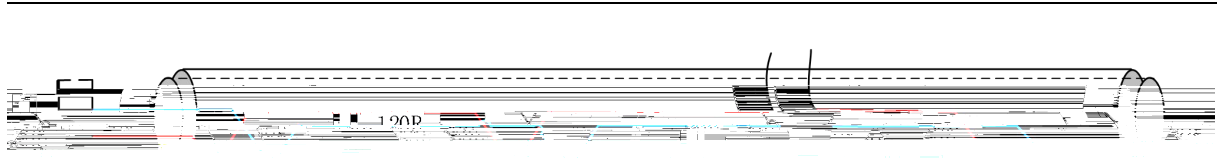

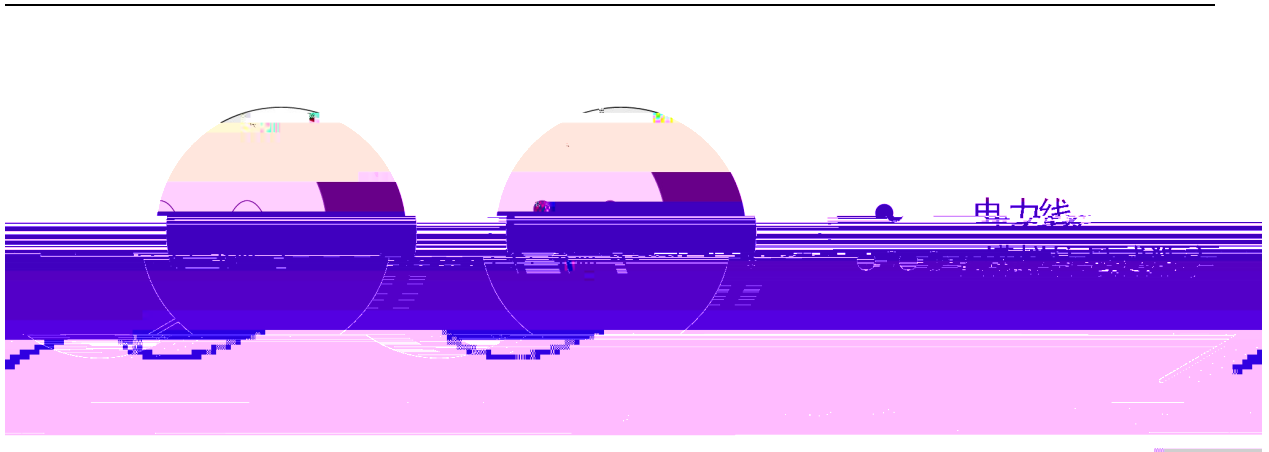

---

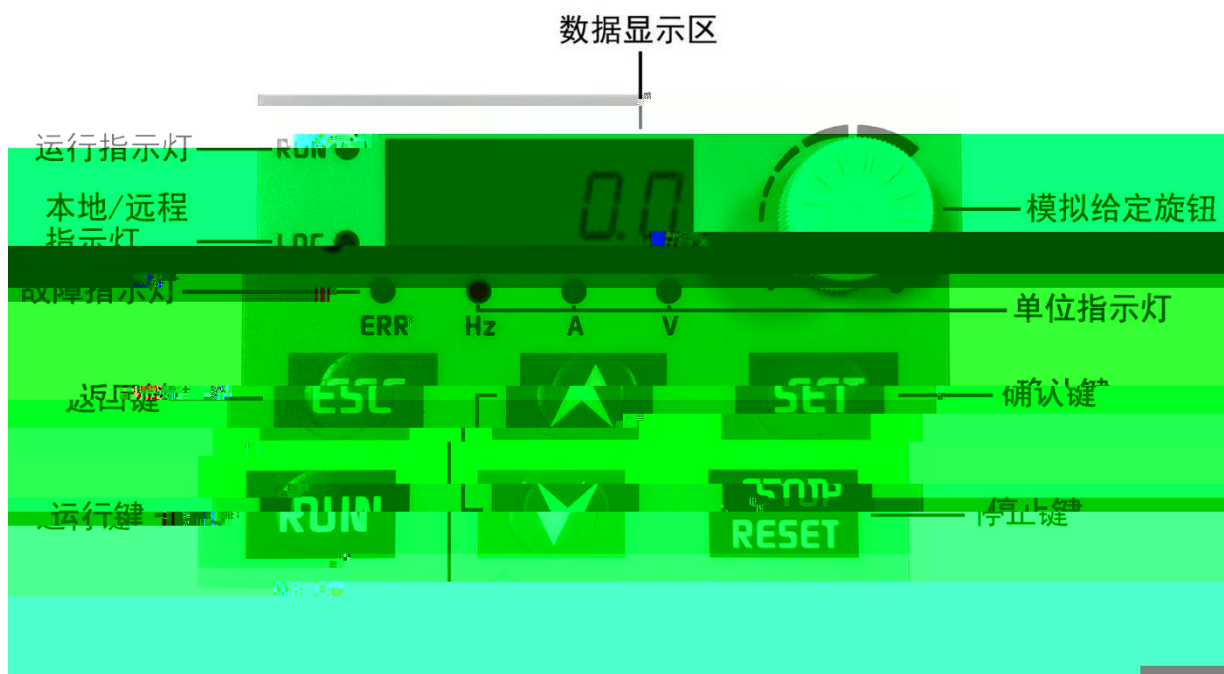



显示文字	LED显示	显示文字	LED显示	显示文字	LED显示	显示文字	LED显示
0	0	A	A	K	Ƨ	U	U
1	1	B	B	L	Ƨ	V	V
2	2	C	C	M	无	W	无
3	3	D	d	N	∩	X	无
4	4	E	E	O	o	Y	Y
5	5	F	F	P	p	Z	无
6	6	G	G	Q	q		
7	7	H	H	R	r		
8	8	I	I	S	s		
9	9	J	J	T	t		

		
		





---

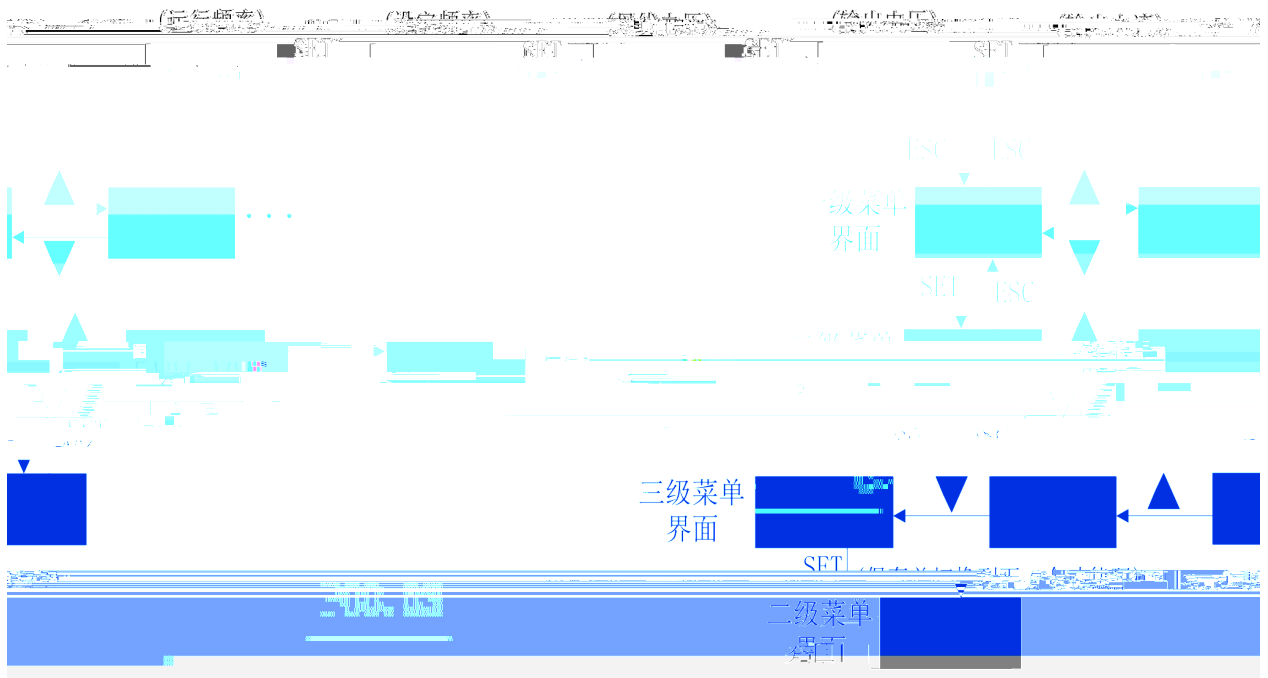

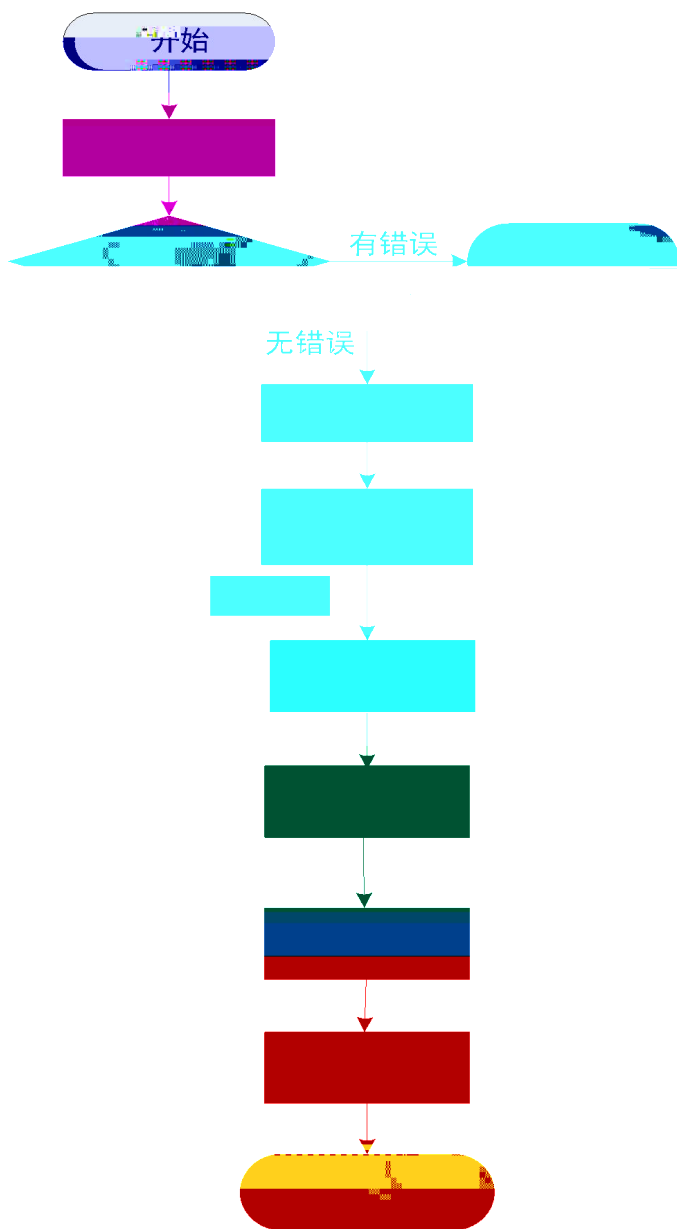



---

---

---



---

---

---



---



# OE

---

o

ö

ö

ä

öLi



---





---



---



---



---

---







---





---

---



---



**GUIDE**





---























---



---







---

---



---



---

			<table border="1"><tr><td data-bbox="550 459 614 526"></td><td data-bbox="614 459 678 526"></td></tr></table>		

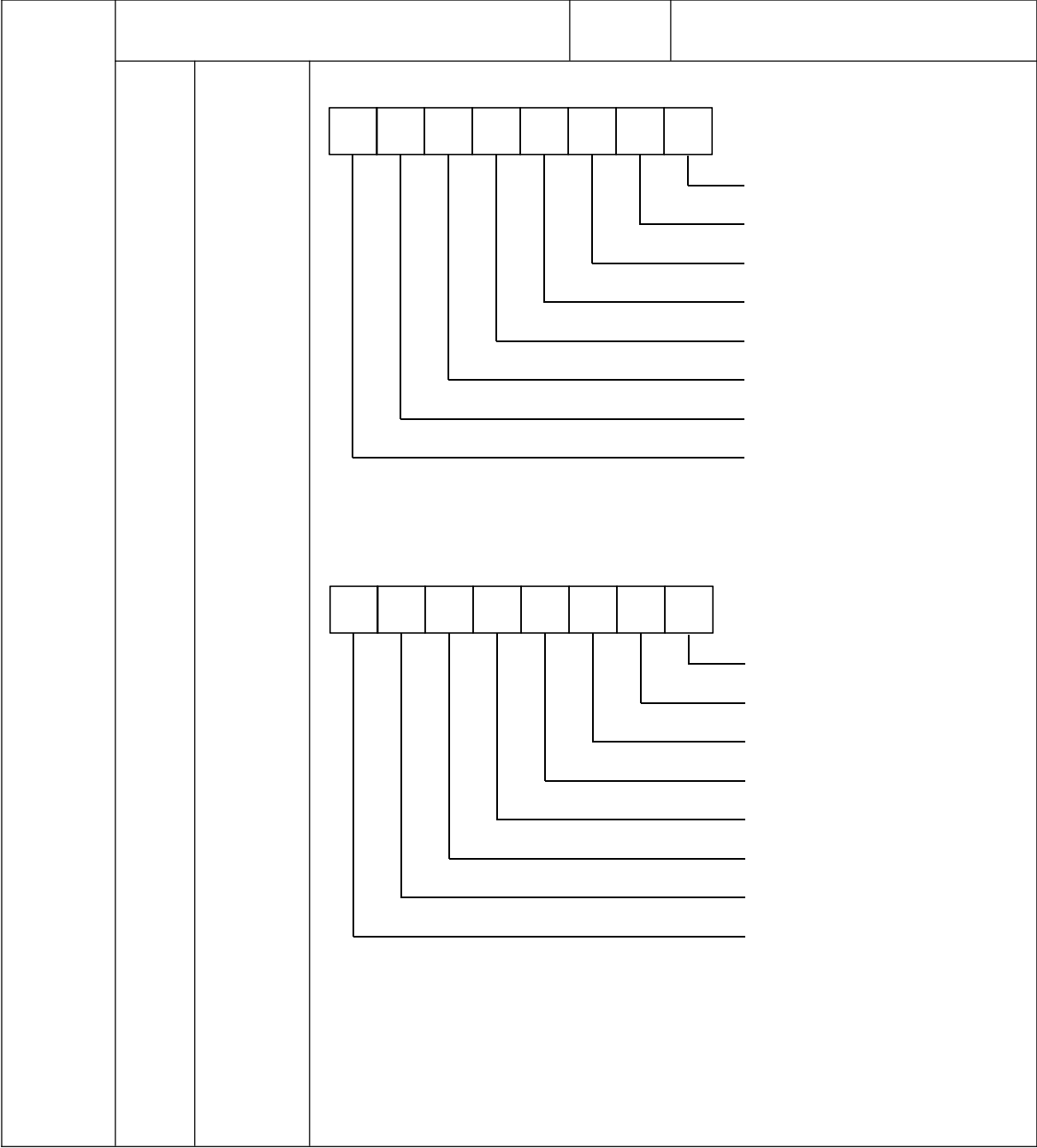

---

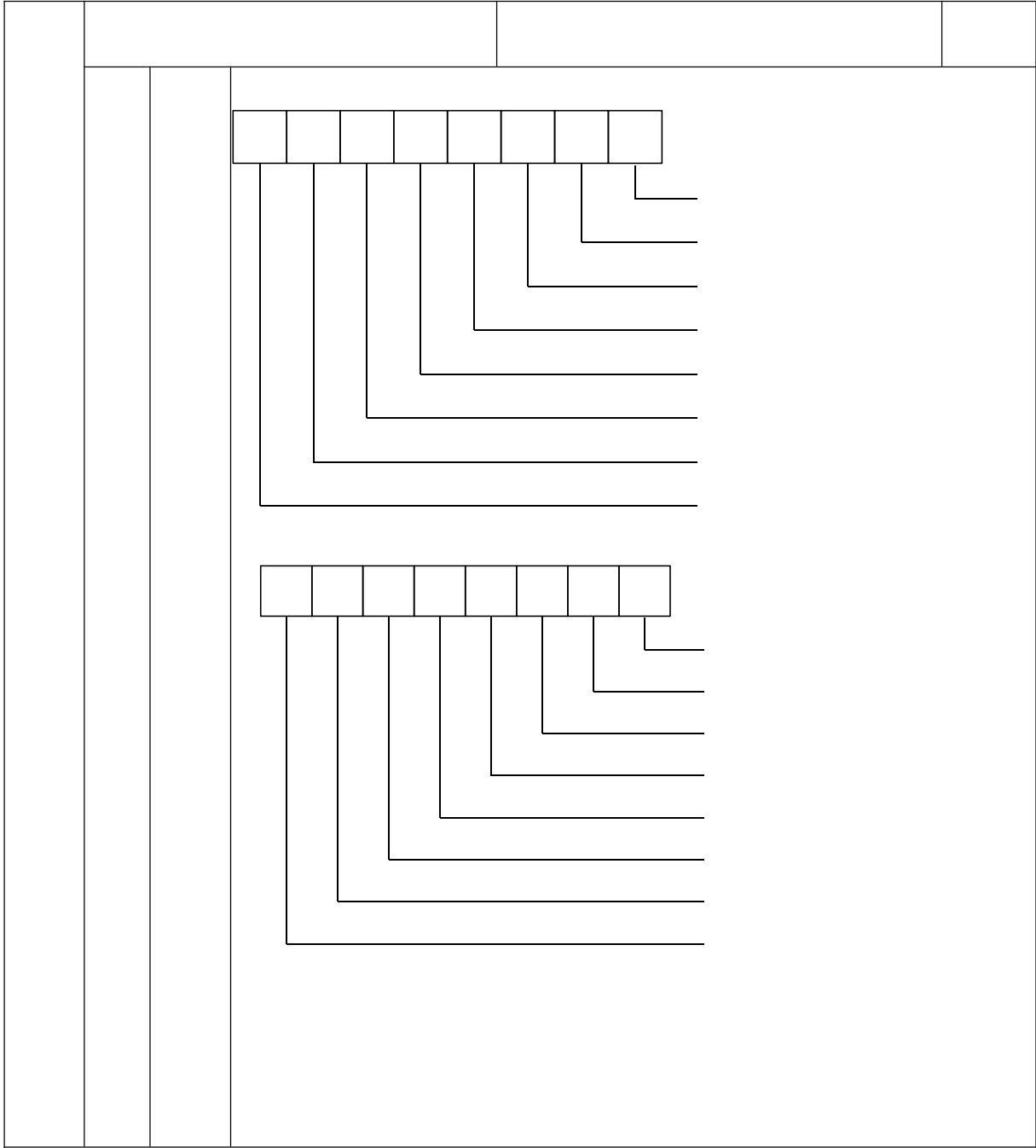









---



---



---

---

---



←

**WAR@**

GUIDE



---

--	--	--



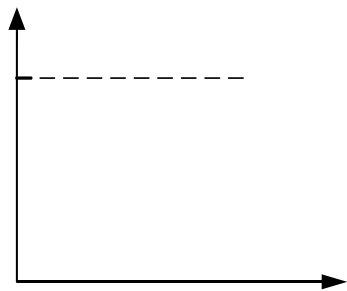

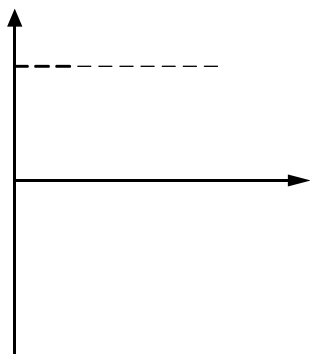

---



---







---



---

---

---

--	--	--

---





**GUIDE**

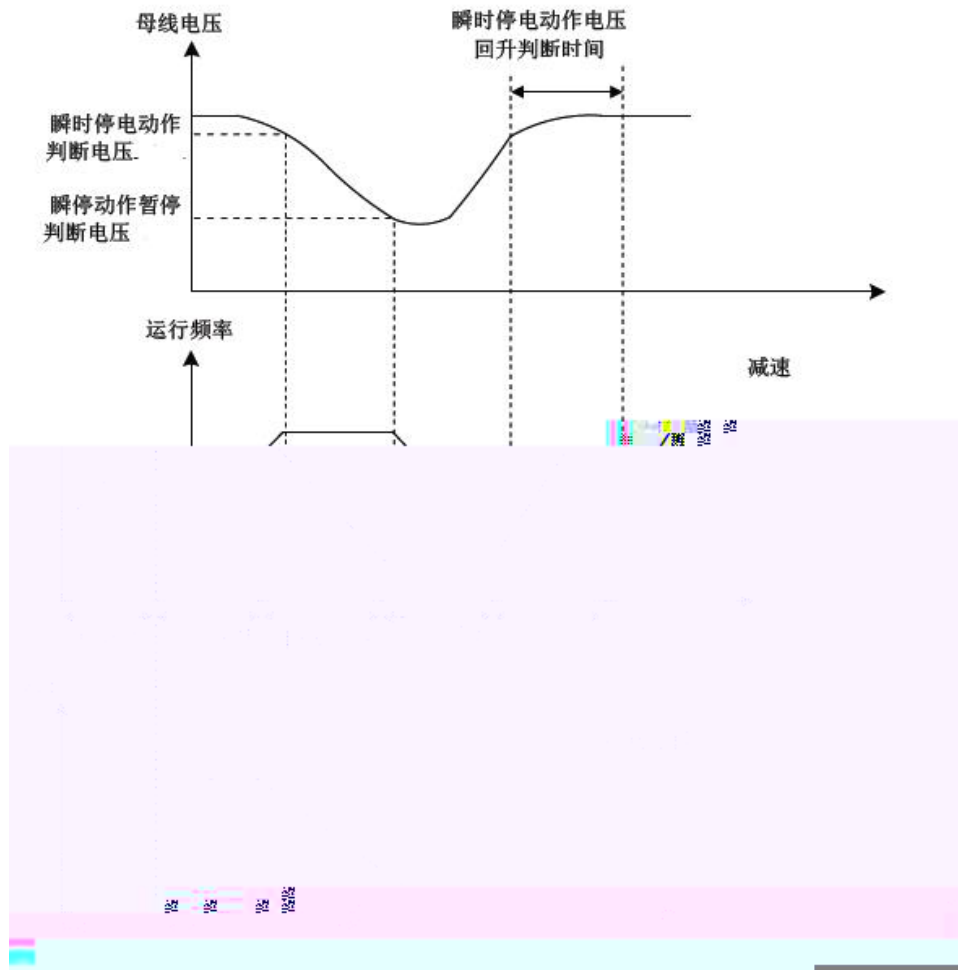

---





---

---



频率源选择

频率源叠加选择

频率源切换设置

目标运行频率

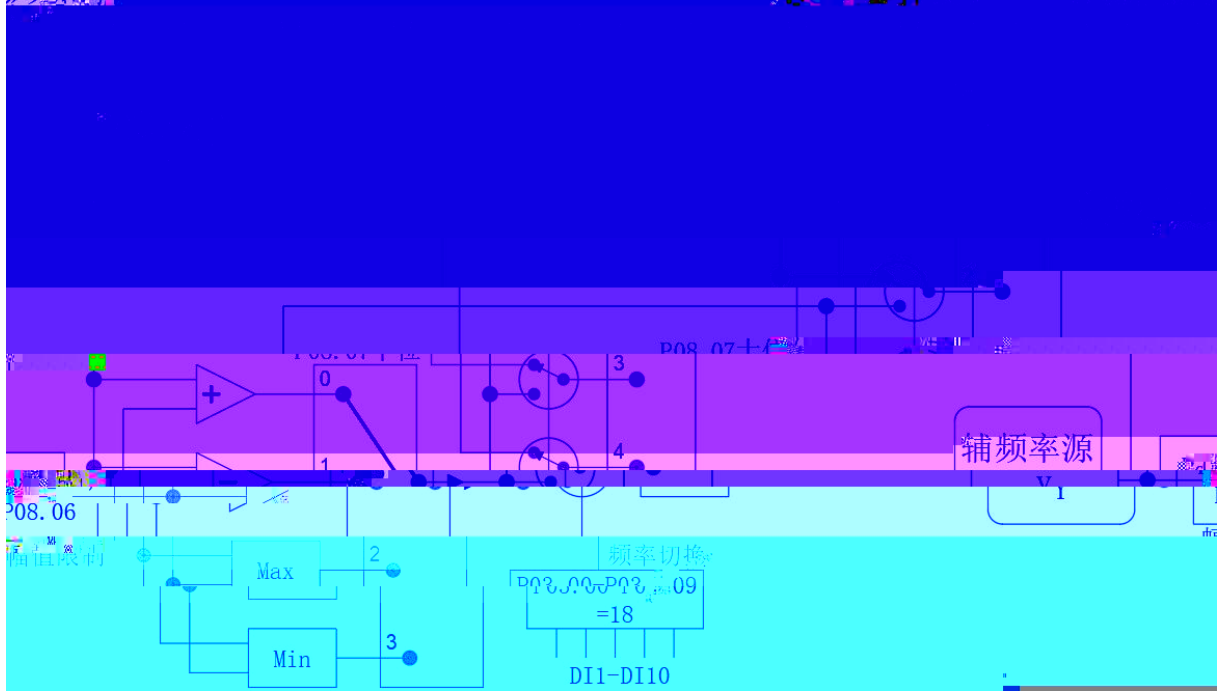

---







---

---



---

\_\_\_\_\_



---

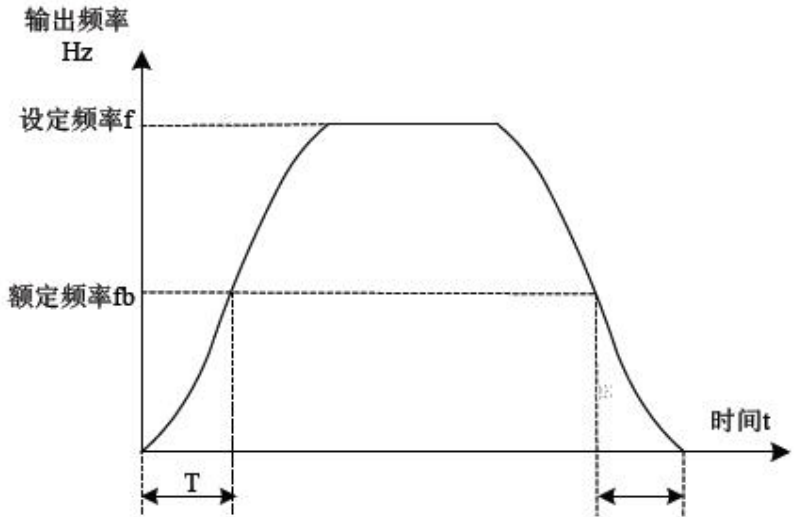
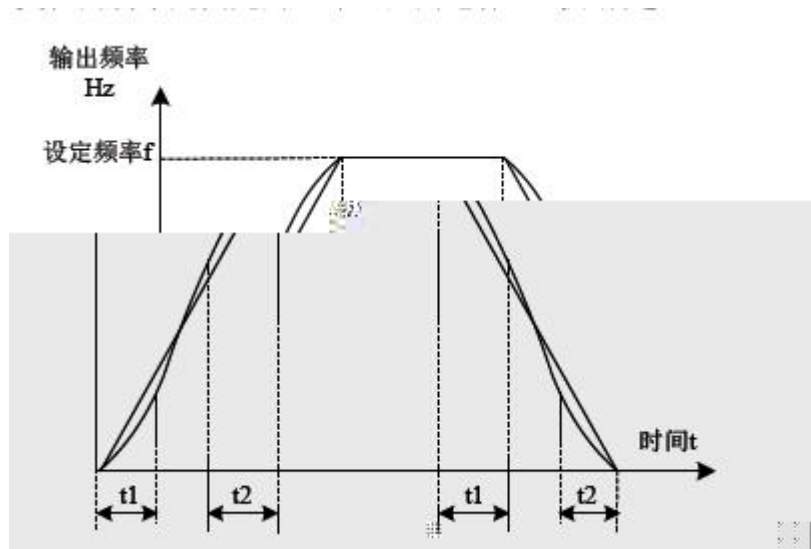

---

# 变频器应用案例

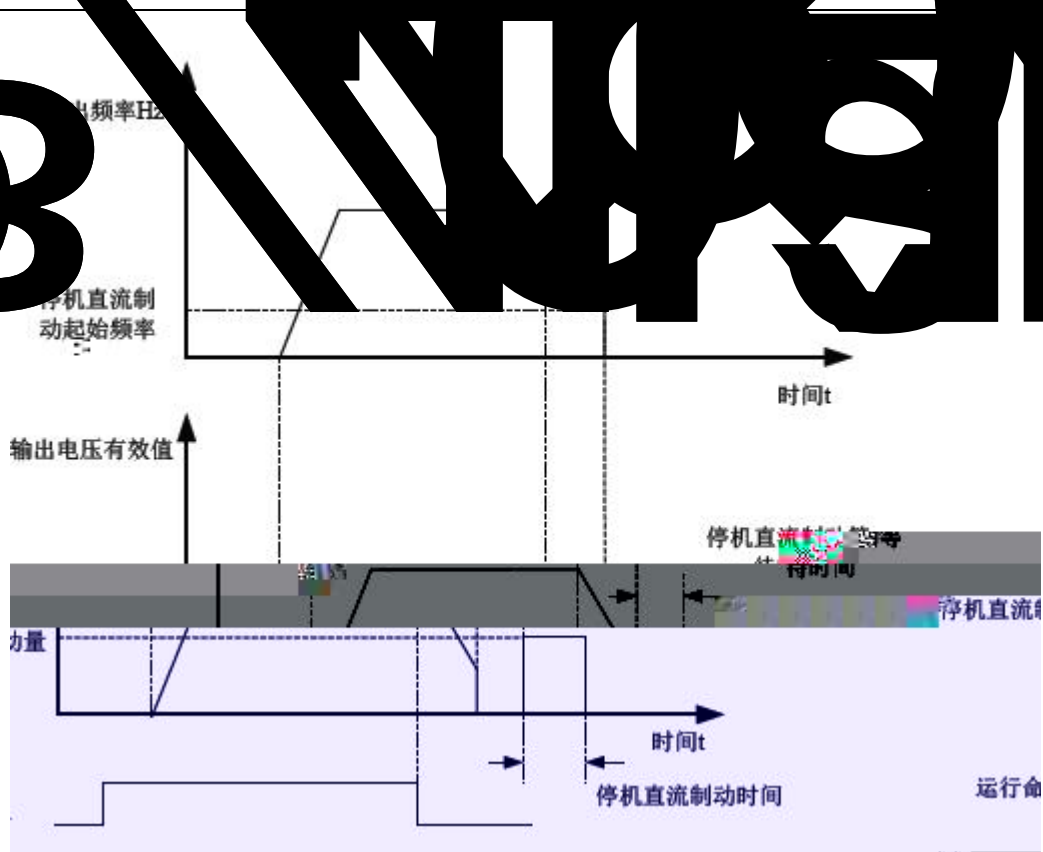

变频器应用案例 | 变频器应用案例 | 变频器应用案例

---

---









---

---

---

---

---

# C

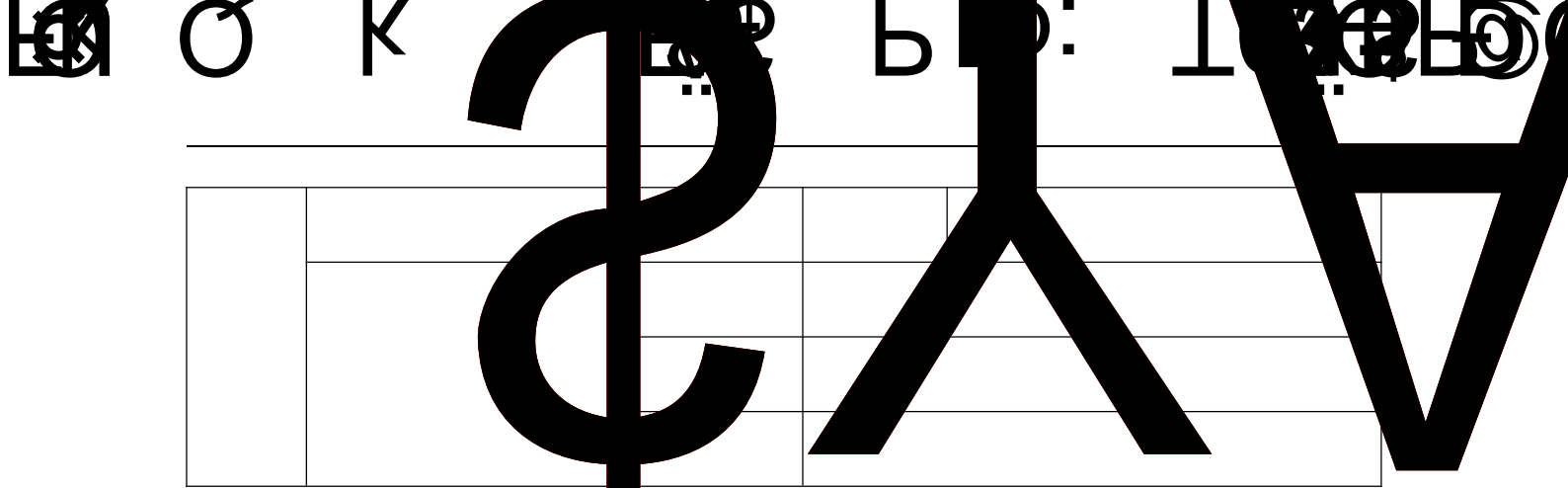

---

02108A:SA <

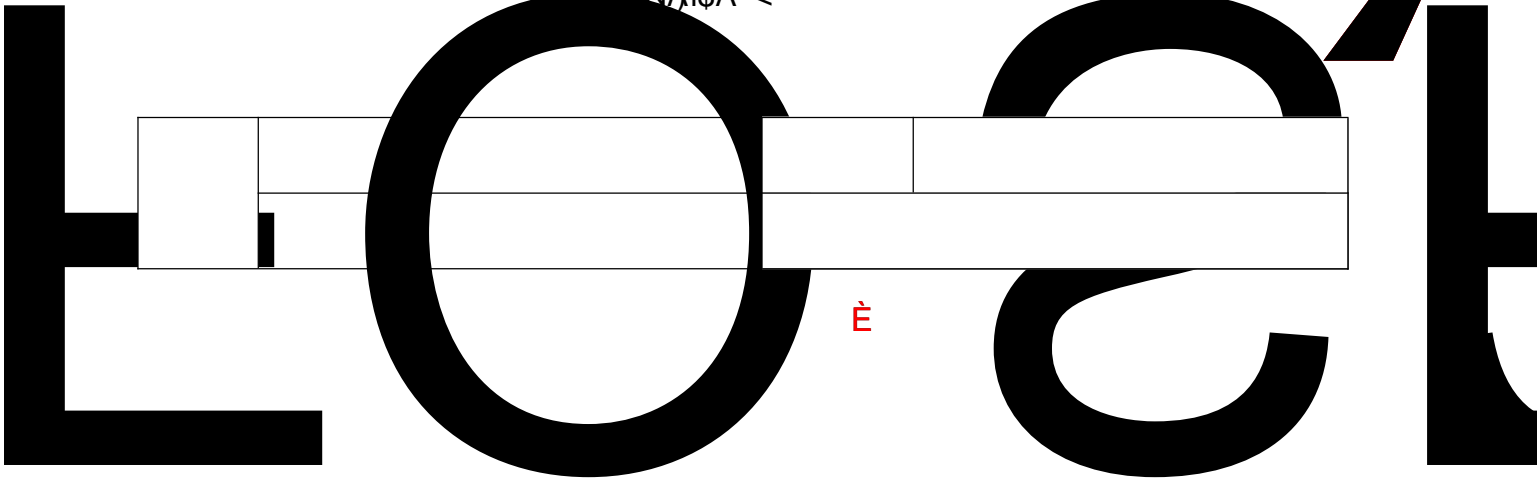

É

3

M0r

· \$YÀ

h

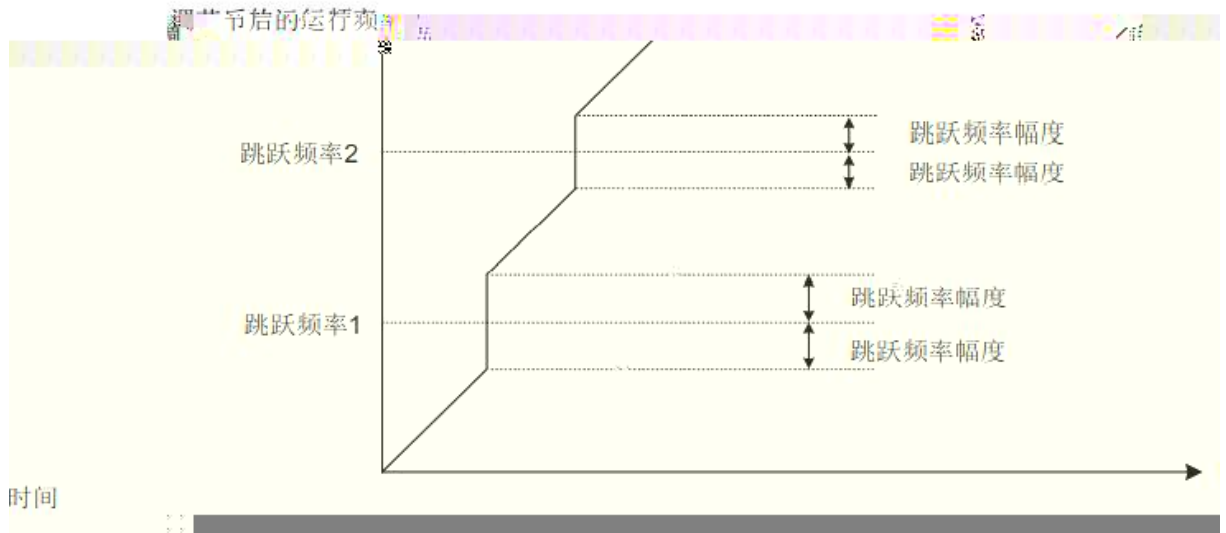

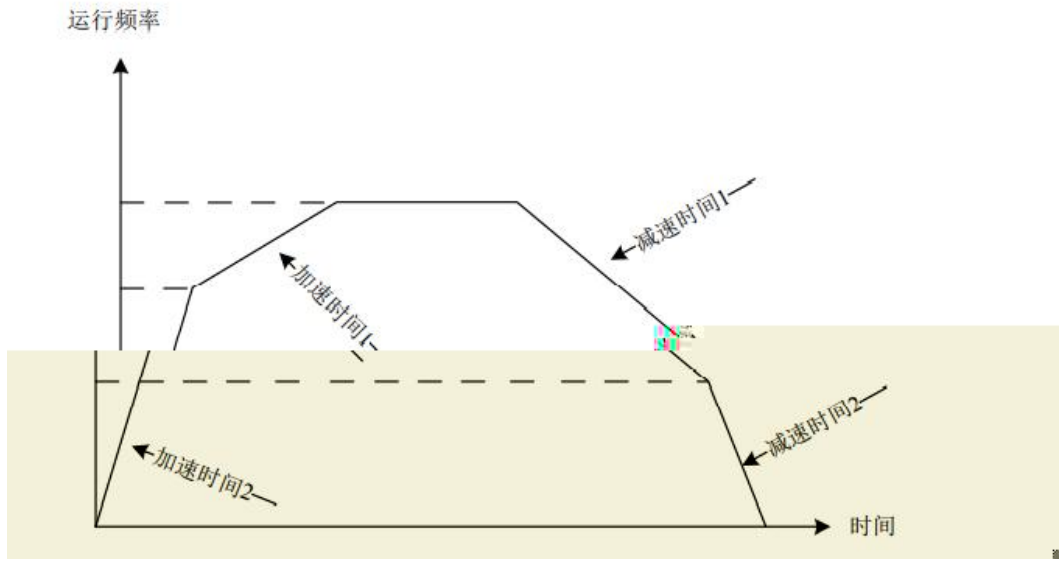





---





---

---

>

---







GF630N01

1. 01

Wuhan Guide Technology Co., Ltd.